



MUMBAI METROPOLITAN REGION DEVELOPMENT AUTHORITY

**MASS RAPID TRANSIT SYSTEM
FOR
VERSOVA-ANDHERI-GHATKOPAR CORRIDOR IN MUMBAI**

VOLUME III B of IV

**Performance Requirements
Performance Specifications and Technical Proposal of Preferred
Bidder**

RELIANCE Energy
Anil Dhirubhai Ambani Group

 **VEOLIA**
TRANSPORT



CONCESSION AGREEMENT

DOCUMENT TREE

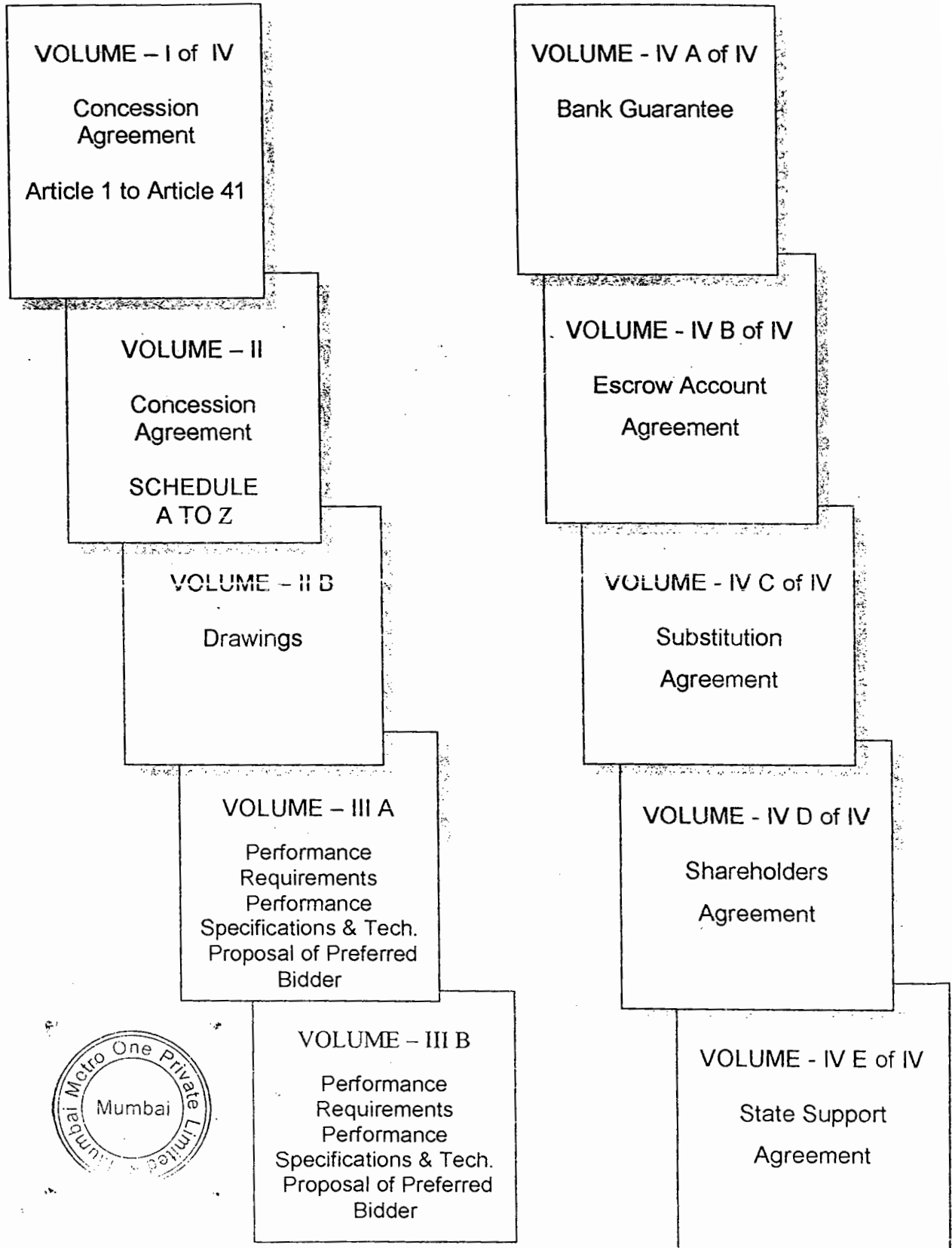





Technical Proposal

Section Sr.No.	TABLE OF CONTENTS	Page. No.
1.0	Executive Summary (Volume III A of IV)	01 - 18
2.0	Reliance Energy Ltd. Company Profile	02 - 18
3.0	Clarification on Queries by MMRDA	01 - 41
4.0	About Connex	19 - 24
5.0	Bid Formats	01 - 02
6.0	4 Car EMU & 6 Car EMU – Technical description	01 - 50
7.0	Concept - Technical Report (Chapter 1 to Chapter 26)	
7.01	Service Requirements	01 - 04
7.02	Site Visit Report	02 - 02
7.03	Alignment	03 - 03
7.04	Survey work – Methodology	04 - 04
7.05	Diversion of Utility Services	05 - 08
7.06	Land Requirement	07 - 07
7.07	Civil Engineering	07 - 27
7.08	Track Methodology	08 - 03
7.09	Station – Planning and Architecture	09 - 11
7.10	Rolling Stock	10 - 13
7.11	Car Depot	11 - 09
7.12	Traction Power Supply and Scada	12 - 18
7.13	Electrical – General Services	13 - 06
7.14	Signaling (Volume III B of IV)	14 - 21
7.15	Communication System	15 - 20
7.16	Automatic Fare Collection(AFC) System	16 - 20
7.17	Operation Control Center (OCC) Facilities	17 - 06
7.18	Commissioning , Test Run and Trail Run	18 - 18
7.19	Operation and Maintenance	19 - 133
7.20	Design Process	20 - 05
7.21	Project and Quality Management	21 - 05
7.22	Construction Programme	22 - 05
7.23	Environment Management	23 - 06
7.24	Safety Management	24 - 35
7.25	List of Construction Equipment	25 - 02
7.26	List of Codes	26 - 07

Part – B
Volume II of RFP

08.0	Performance Specification for (VAG)	01 -25
------	-------------------------------------	--------

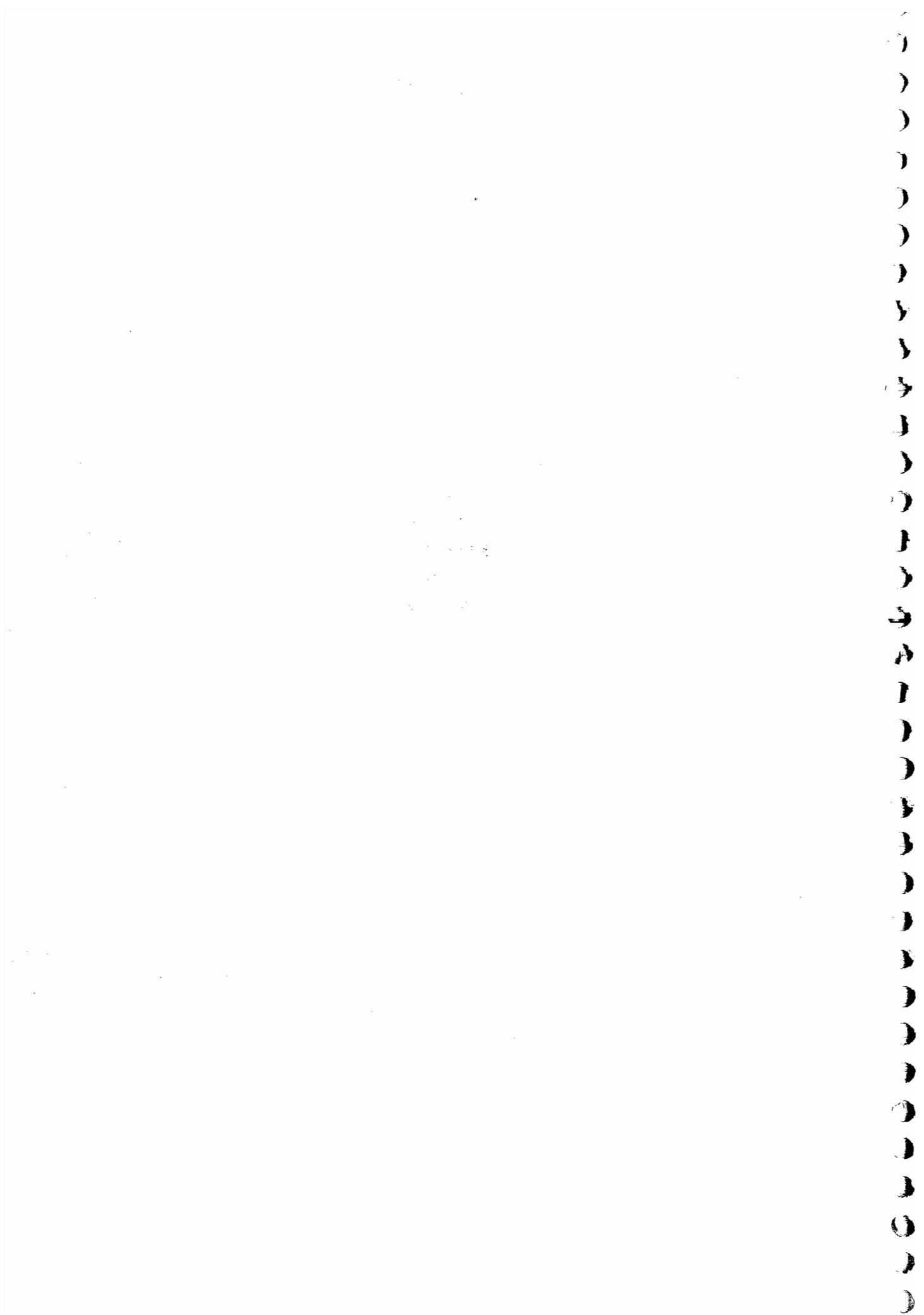

CHAPTER 14

SIGNALING

14.1 Introduction

14.1.1 Track alignment for the corridor is on elevated structures from Versova to Ghatkopar including the spur line from Airport Road to Airport station. For this dedicated track for Mass Transit of commuters, train control and signaling system has been designed to meet a design headway of 120 seconds. It shall comprise modern Automatic Train Protection (ATP) system with CAB signaling. The line side signals will also be provided at all stations with points and crossing, which shall be used for the purpose of back up signaling to allow bidirectional running. The system shall be based on fixed block principle. All the stations with points and crossings shall be provided with one set of Computer Based Interlocking (CBI) with facility to operate these points and crossings locally as well as being centrally controlled from Operation Control center (OCC). The CAB-borne and wayside signaling equipment shall be designed with sufficient redundancy so as to meet the desired reliability and availability requirements. The proposed system will have self diagnostic & predictive on-line maintenance feature to minimize the failure & recovery time. The mimic panel for this corridor shall be housed in the OCC at DN Nagar. The depot shall be provided with an independent Computer Based Interlocking.

14.1.2 ATP system is one of the vital systems for the safe operation of the Railway. It is classified as a safety critical item. It must be built on the highest safety integrity (SIL) level. SIL level will commensurate with the worldwide requirement of subsystem of ATP. Safety management as well as safety activities throughout the life cycle of the ATP project shall be recorded and submitted as "Project Safety Report" to demonstrate to the inspectorate of Railway the safety concerns and hazards, how they are dealt with, sufficient rules and procedures are laid down and appropriate training is provided to operate and maintain the system.

14.1.3 The proposed ATP system will have capability of upgrading to Automatic Train Control (ATC) system with no major change on the system architecture if required at later stage due to increase of traffic demanding service headway of less than 2 minutes. Automatic train operation will be provided when the traffic demand requires a headway of 2 minutes or lower.

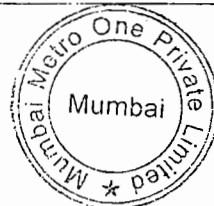

- 14.1.4 The design of the signalling system will be such that, (if not supplied initially) it will be upgradeable to ATO with no significant affect on operations.
- 14.1.5 ATP, ATS, CBI and Point Machines will have self diagnostic features
- 14.1.6 "Wrong way" running will be possible with the proposed system
- 14.1.7 The design of the Signalling system will be compatible with the Rolling Stock.
- 14.1.8 The proposed Traction System will be compatible with the Rolling Stock and the signalling system to be supplied.

14.2 Technical and Operational Requirement

14.2.1 The proposed Versova- Andheri- Ghatkopar elevated Metro Rail length has to provide train services at four minutes headway initially and capable of being upgraded economically when shorter headways are required with ability to operate at headway of less than two minutes in peak periods. The fixed block multiple aspect colour light signaling (MACLS) would not be sufficient to meet this requirement with the given track layout and Rolling stock parameters. With MACLS, phased increase in capacity is costly and restoration to normal service following interruption or breakdowns, is slow. The available operation margins get reduced to a level that is not manageable with manual operation and would depend upon from individual to individual. Serious accidents can occur with MACLS due to human error. To overcome all these, and at the same time to maintain safe train operation, a more reliable, efficient and safe signaling system is needed for headway approaching 3 minutes. Only modern signaling systems can meet all these requirements for initial as well as long term goals of operation. With these objectives, train control and signaling systems have been planned with Automatic Train Protection (ATP) and Automatic Train Supervision (ATS) function initially and upgrade it later on with Automatic Train Operation when train operation with less than two minutes is needed. The proposed ATP and ATS will be designed to meet the required safety and technological standards to be compatible with 25 kV AC traction and Rolling stock.

14.2.2 The Designed Headway for this corridor shall be 120 second with adequate factor of margin for :

- i. Maximum train length of 135 meters.
- ii. Station dwell time of 20 seconds.
- iii. Average speed of 33 km/hr.



iv. Attainable speed of 80 km/hr.

14.2.3 A preliminary train simulation is conducted with all the proposed data of EMU performance characteristics such as acceleration, deceleration, braking etc. (as stated in Chapter 10), available track alignment data provided by MMRDA, short overrun at Ghatkopar (about 3 meters only) and does not allow to use diamond crossing (as indicated by MMRDA in the addendum). Based on the above conditions, the simulation results indicate that the requirement of single journey time of no more than 21 minutes between Versova and Ghatkopar can be achieved. The best achievable design headway is 3 minutes (see Figure

14.11) due to the short overrun provided at Ghatkopar Station. All trains must be required to reduce the speed early to avoid overrun when approaching to the station.

14.2.4 If Ghatkopar Station is allowed to shift towards the west by about 40 meters, the design headway can be improved to 2.5 minutes. In addition, if the diamond crossings are also employed, the best design headway can be then further improved to 2 minutes (see Figure 14.12). The simulation results with different scenarios are summarized in the following table:

Scenario	Description	Design Headway	Signaling System
1	Original track layout.	3 minutes	ATP with CLS
2	Employ diamond crossing	2.75 minutes	ATP with CLS
3	Extend the overrun by shift Ghatkopar Station towards the west about 40 meters.	2.5 minutes	ATP with CLS
4	Employ diamond crossing and shift Ghatkopar Station towards the west about 40 meters.	2 minutes	ATP + ATO

14.3 Design Approach

14.3.1 The Train Control and Signaling System shall provide for the safe routing, spacing, movement and control of trains.



- 14.3.2 The Train Control and Signaling System shall provide for hot swapping for all plugs in modules and this shall not affect the normal and emergency operation of the system.
- 14.3.3 The Train Control and Signaling System shall not lead to an unsafe condition when the plug in module/card/equipment is taken out.
- 14.3.4 The probability of Wrong Side Failure shall be less than 10^{-9} per train operating hour for the complete Train Control & Signaling System supplied, installed and commissioned under this contract.
- 14.3.5 The safety performance requirement shall be achieved with a calibration/inspection interval of not less than 1 year.
- 14.3.6 The Train Control and Signaling System shall achieve all performance requirements specified in this proposal.
- 14.3.7 The system shall meet or exceed the requirements of CENELEC Standards EN50126, EN50128 and EN50129 for Reliability, Availability, Maintainability and Safety of electronic signaling equipment, or equivalent.

14.4 Proposed System Technology

14.4.1 The Signaling and Train Control System can be divided in five functional areas. They are:

- a) Depot Signaling,
- b) Passenger Main Line Conventional Signaling,
- c) Automatic Train Protection System,
- d) Automatic Train Operation System,
- e) Automatic Train /Traffic Supervision System.

14.4.2 The Depot Signaling System controls and monitors the movement of trains/rakes within the depot including the test track movements and entry and exit from the depot.

14.4.3 The Main Line Signaling System controls and monitors the movement of trains with bi-directional running and employs conventional fail safe equipment like point machines, locking and detection, colour light line-side signals, signaling panels and Computer Based Interlocking.



14.4.4 The Automatic Train Protection System consists of the trackside system and train-carried system. The track-side system using joint-less track circuits or loops transmits maximum safe speed and target speed information to the train-carried equipment. On board each train, the equipment constantly monitors the condition of the track and the train speed to ensure that the train never enters an unsafe situation. If a train enters a dangerous or potentially dangerous situation, emergency brakes are applied in time so as to bring the train to a halt in a safe manner.

14.4.5 The Automatic Train Supervision System performs the function of traffic monitoring and control through continuous train location monitoring, train routing and schedule the running of each train as per time-table or as per regulation algorithm, if there is deviation from the time table or the traffic needs so warrant.

14.4.6 The Automatic Train Operation System regulates the train speed to the desired optimum operational inter-station performance. The system performs most of the routine work of an efficient conventional train driver-cum-traffic controller.



14.4.7 The following block diagram showing the system architecture of the proposed Signaling System:

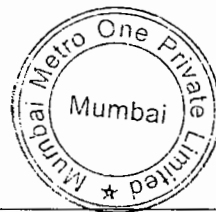
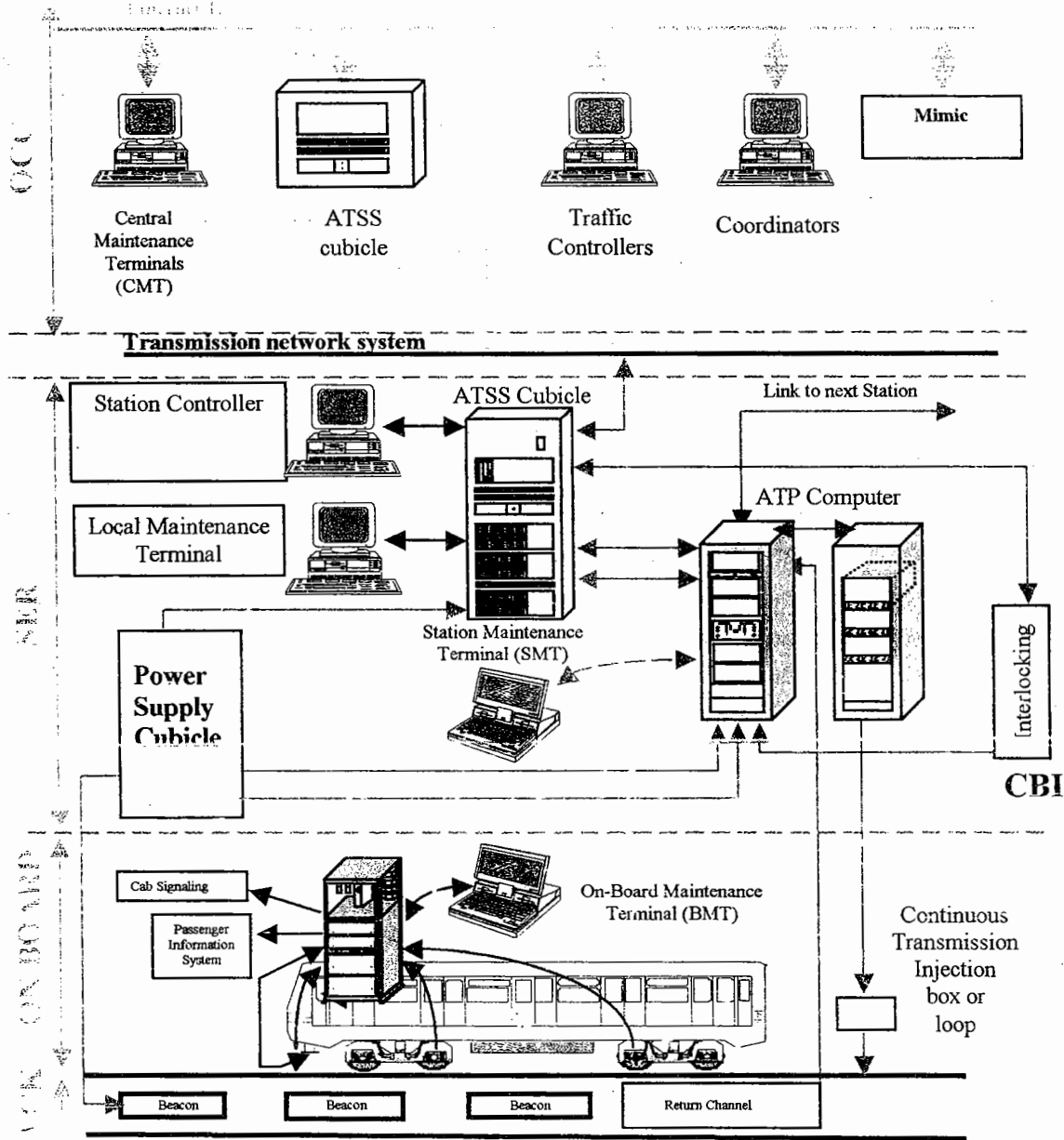

14.5 Train Control and Signaling System

14.5.1 Automatic Train Protection (ATP) System

14.5.1.1 The vital ATP system shall provide continuous cab signaling which automatically limits the speed of trains to the Target Speed (TS) of the routes set by the Signaling system and brings a train to a halt clear of a detected obstruction. Fixed block technology shall be employed.

14.5.1.2 A Maximum Safe Speed (MSS) of some 3kph above the TS value is permitted as a margin for practical purposes; in the event that the MSS is exceeded, an emergency brake application shall be initiated.

14.5.1.3 Permanent and temporary speed restrictions or blocking, set at the trackside, shall be automatically complied with.

14.5.1.4 The ATP trackside transmissions with the trainborne ATP control equipment providing continuous cab signals shall be designed in accordance with fail-safe principles. Trainborne ATP equipment interfaces with the train systems for control of the propulsion and emergency brakes.

14.5.1.5 The functional requirements of the ATP are, as follows:

- Only permit forward train movements;
- Prevention of trains entering a route that is not set and locked;
- Safe braking distance to an obstruction
- Safe separation between subsequent trains;
- Over-run protection;
- Train speed measurement;
- Target Speed indication at the train cab odometer;
- Over-speed audible warning in the train cab when the actual speed is exceeds the Target Speed;
- Initiate an Emergency Brake application when an unsafe condition is detected.
- Rollback detection
- Zero velocity detection
- Over-speed initiation of emergency brake application
- Train door control

14.5.1.6 The ATP major trackside equipment shall include:



- Signaling sub-system interface logic controller;
- ATP code generators;
- Code selection logic controller;
- Track circuit interface.

14.5.1.7 The ATP major train-borne equipment shall include:

- Antenna
- Vital processor
- Tachogenerator
- Odometer
- I/O interface with train systems

14.5.2 Automatic Train Supervision (ATS) System

14.5.2.1 The ATS enables management of the Signaling and Train Control System from the OCC by providing overview of the transit system operating status, in approximation to real time. ATS automates the normal operation of the traffic control and supports manual intervention by OCC staff during abnormal working situations.

14.5.2.2 Workstations shall be provided for the OCC staff to operate the signaling system and a mimic panel depicting the transit system track layout and signaling arrangements. Data for various timetables generated at the Schedule Compiler, shall be stored in the ATS Central Computer memory for implementation, as and when required, for various service demands.

14.5.2.3 ATS data for service train description and location shall be communicated with the Passenger Information System (PIS) and train radio, for train stepping and identification functions.

14.5.2.4 ATS data shall be transmitted between the ATS Central Computer and the field Local Processor Units (LPU's) located in each station signal equipment room via the Data Transmission System. LPU's are networked together and provide the data to support the automatic working at a local level.



14.5.2.5 For the event that the OCC is not available or during maintenance activities, Local ATS (LATS) are proposed at each station. These facilities will enable the station staff monitor normal working and provide manual support during abnormal working conditions. The Local ATS facility shall support automatic train supervision from data stored in the LPU, for automatic route setting and reporting, in accordance with the service timetable.

14.5.2.6 Engineers for ATS workstation shall be provided in the equipment room of the Central Control for maintenance and software up-date activities.

14.5.2.7 UPS with a minimum of 2 hours battery supply shall support the ATS Central Control facilities.

14.5.2.8 The functional requirements of the ATS sub-system are, as follows:

- Overview the revenue line operations status, in proximity to real time;
- Alarm potential operating hazardous events;
- Record operating events and alarms (sufficient to reconstruct an incident) ;
- Overview of the signaling system status (routes, points, signals, blocking inhibits);
- Automatic route setting;
- Manual routes setting and point operation;
- Enable blocking of tracks, signals/routes and points;
- Compile service timetable data (Schedule Compilation);
- Display train description (ID Number) at the OCC mimic panel;
- Local (Station) control;
- Radio communication with each train (by ID Number);
- Interface with Train Radio for Passenger Information System;
- Enable holding of trains in a platform(s) by modifying the ATP proceed code;
- Enable adjustment to platform dwell times;

14.5.2.9 The ATS major equipment shall include:

- Central Computer. Dual system with the redundant computer in hot stand-by mode;
- OCC mimic panel;
- Workstations (Operator and Engineers) ;
- Printer;
- Schedule compiler;



- Train Descriptor;
- Clock;
- Data Transmission System;
- Field LPU's and interface with the signaling, ATP field equipment; and
- Local ATS computers

14.5.3 Operation Control Centre (OCC)

14.5.3.1 The OCC for this corridor shall be housed in the OCC at D.N. Nagar. It will be manned round the clock and provide control for train service, power system and environmental systems as well as incident handling. This control centre provides control and supervision for all train movements for the proposed corridor. Station control fallback operation is also provided. It allows control of train movements within the station control boundaries. Train movements across boundaries are normally automatic and in some case it will need co-operative working between adjacent stations.

14.5.3.2 There are two consoles for the corridor and each console layout is exactly the same. Each console is manned by one Traffic Controller managing one half of the line. In case of emergency or incident handling one controller will take up the control of the whole line and leave the other focuses on the incidents

14.5.3.3 An engineering console is located inside the control centre. It allows close co-ordination between operators and engineers and speedy recovery of service to be made when there is service disruption due to equipment breakdown.

14.5.4. Mimic Over View System

14.5.4.1 A mimic panel will be provided in the OCC, which will display the following information to facilitate traffic controllers in their activities:

- Real time train movement using track circuits / cable loop status.
- Display train ID of moving train.
- Position of points (locking & detection) & status of routes.
- Track circuit failure or track circuit "put out of service" shall allow the progression of train movement to be followed on the mimic panel without the loss of train description using train tracking algorithm.
- Status of Public Information system, Public address system



14.5.5 Computer Based Interlocking (CBI)

14.5.5.1 There shall be 13 stations in all on main line, out of which 6 stations shall be with points and crossings. Carshed lines shall also have points and crossings.

14.5.5.2 All the main line stations with points and crossings shall be provided with a Computer Based Interlocking (CBI) with facility to operate from OCC and also locally as a back up, if need arises. Computer Based Interlocking shall be provided for Versova, Andheri, Airport road, Sahar Airport, Sakinaka, Ghatkopar and DN Nagar depot.

14.5.5.3 The proposed alignment is on elevated structures, including car-shed lines. Versova station, besides being a terminal, also caters for stabling facilities and entry and exit from the car shed. Ghatkopar is the terminal station at the other end of the alignment. Reversal facilities are provided at the intermediate stations Andheri, Saki Naka and Airport Road. Airport Road also serves as the entry and exit for the spur line to Airport station. Interlocking systems are provided at the Car-shed, Versova, Andheri, Saki Naka, Airport Road, Airport and Ghatkopar. While the Car-shed interlocking will be locally operated, the operation of the movements will normally be operated from the Operations Control Centre at Versova. For compatibility with the modern ATP system interface, modular form, self-diagnostic equipment with maintenance friendly microprocessor based interlocking is proposed at all stations with automatic route setting. Electric point machines will operate all points. Signal and track circuit equipment will be centralized at interlocked stations interlocking to keep the outdoor equipment to a minimum for easy maintenance and minimize cost.

14.5.5.4 The CBI shall provide the following functions:

- Route setting on entrance/exit principles;
- Interlocking against conflicting routes;
- Flank protection;
- Point detection and track-circuit clearance;
- Route over-run protection;
- Signal indications to support Line of Sight driving procedure;
- Bi-direction working on each Line, between adjacent interlocking stations;
- Route holding of a set route, when a train is approaching, within the route and the overlap;



- Release of the route by the passage of a train or by the route cancellation at the OCC or station control when the train has come to a standstill;
- Route, point and track circuit Blocking;
- Exchange trackside information between main line and depot signaling system;

Major equipments of CBI shall include:

- Local ATS (LATS) Workstation
- Computer Based Interlocking (typically, "redundant" processors);
- Track circuits – jointless AF within the sections of Continuously Welded Rail (CWR) and jointed within the special trackwork;
- Electric point machines (locking for facing movements) and detection;
- 2 aspect Signals;
- Fixed buffer stop lights; and
- Blocking and route inhibit facilities.
- Platform Emergency Plungers (at platform)
- Platform Emergency Switches (inside Station Control Room)

14.5.6 Station Control Room

14.5.6.i Station Control Room is equipped with all the control terminals for signaling and power system. The control limits are within the defined station control boundaries. Local controls are also provided for safety critical functions. Apart from that it also provides control of escalator movements, station lighting, fire control system, ventilation and miscellaneous E&M systems of the station and Automatic Fare Collection system such as entry-exit gates, ticket vending machine etc. Normally all controls are executed from the central control room. It will only switch to station control when it is more effective to control the systems locally such as when system failure occurs and needs to operate at degrade mode of service or when an incident is being handled locally.





CBI- EQUIPMENT ROOM - WAY SIDE STATION

14.5.7 Signaling Equipment Room

14.5.7.1 The signaling equipment room will be provided at 6 stations. It houses the ATS system, CBI, ATP system, one power cubicle and trackside equipment cubicles. All critical equipment are duplicated and CBI is configured in two out of three. A technician terminal and a data logger for CBI are provided for fault diagnostic. A serial link port is provided at the ATP computer rack for portable PC to download and view the equipment status.

14.5.8 Lineside Signals

14.5.8.1 Lineside signals shall be installed on main line stations at the entry to all routes (interlocking) for bi-directional working. Signals shall be two aspect colour light signal. The sizes of the signal unit shall be so designed that it does not infringe the requirements of structure gauge without affecting the visibility of the signals. All main and subsidiary signal lamps shall be LED lamps. Route indicators shall be provided to indicate each route wherever a signal can lead to more than one route and shall be mounted on the signal in such a way that it does not infringe



the requirements of structure gauge. Shunt signals shall be position light type. Lamp proving shall be provided for all lineside signals including cross, route indication of signals and shunt signals.

14.5.8.2 Line side Signal Aspects

Signals shall display the following aspects.

1. When cab signal equipments is working, (Red / Green) shall not be lit and the fixed colour light signal will have two white lit cross bars on the post below the main signal to indicate the ATP working.
2. When cab signal equipments is not working or train is running in the manual mode :
 - a) Red – stop dead.
 - b) Green – route set and locked and the track is clear up to next interlocking.

The two white lit cross bars used to indicate the ATP working shall be extinguished in this case. Stencil type route indicators above the main signal shall be used to display "M" or "D" as the case may be for both manual and ATC working to indicate the movement through the interlocking.

14.5.9 Isolation

14.5.9.1 Provision of conventional isolation between main line & stabling siding ahead of platform at Versova has been dispensed with as parking brakes on Rolling stock proposed to be provided shall afford necessary safeguard.

14.5.9.2 Parking brakes shall be capable of holding a fully loaded stationary train on 4% gradient under all track conditions, indefinitely. These stabling lines shall be used for stabling of rakes during night only.

14.5.10 Point machines

0



14.5.10.1 The point machines on the main line shall be electrically operated of non trailable type, with high thrust & suitable to drive thick web switches. The point machines for the depots shall be of trailable type.

14.5.10.2 The On-line Point Diagnostic System will also be provided. It will provide information on the current operating state, changes in the operating state and deficiencies in point before it happens. It is a parameter measuring system for determining the power curve of an electromechanical point machine. On the basis of this data, conclusions are drawn which are used to evaluate the points in their function as an electrical and mechanical system. The diagnostic principle is based on the proportionality between the mechanical-force output and the active-power input in large areas of the operating parameter range of the electrical point machine. The point diagnostic system includes high-precision sensors which are connected to a 19" board-rack system and evaluated by means of specially developed software.

14.5.11 Track circuits

14.5.11.1 Audio frequency track circuit for detecting the presence of vehicle on track shall be used. In addition, axle counter shall be used to backup track circuit at critical location of which failure will significantly affect the train services such as terminal station with crossovers and the reception track of depot with single in/out track. These are the modern signaling equipment and are being used extensively worldwide including Indian Railway.

14.5.12 Safety standards

14.5.12.1 All the vital/non vital systems shall meet the same safety and other CENELAC standards as has been adopted for Worldwide Railway and Metro corridors. Safety standards will commensurate with the safety requirement of the system so as to ensure safety as well as cost efficient system

14.5.12.2 The ATP system shall provide the fundamental safety control of train running and shall be a Fail Safe system of Safety Integrity Level (SIL) 4 as defined in EN50126, EN50128 and EN50129.

14.5.12.3 All ATO functions (if fitted) shall be performed at Safety Integrity Level (SIL) 2 as defined in EN50126, EN50128 and EN50129.



14.5.13 Earthing and Lightning protection

14.5.13.1 All the equipments shall be provided with proper earthing and lightning protection in an attempt to avoid any damage to the equipment or working personnel on the system due to any abnormal conditions.

14.5.14 Redundancy

14.5.14.1 The CAB-borne and wayside signaling equipment including CBI shall be designed with sufficient redundancy to meet the reliability and availability requirements with easy access for maintenance.

14.5.15 Depot

14.5.15.1 The depot Signaling system shall be a two-aspect signal system for Line of Sight driving procedures. The interlocking shall be vital Computer Based Interlocking (typically "redundant" processors) controlled from a workstation located in the OCC building. Route setting shall be of the entrance / exit philosophy and the design in accordance with fail-safe principles; associated software shall be validated in accordance with IEC 65A Standard Integrity Level (SIL4).

14.5.15.2 Transfer of trains between the depot and revenue line shall take place in a defined section of the Depot Link Line, adjacent to the Depot entrance.

14.5.15.3 The functional requirements of the depot signaling system are, as follows:

- Overview the operational status of the Depot layout, in proximity to real time;
- Overview the depot Signaling system status (routes, points, signals, blocking inhibits);
- Manual setting of routes by entrance/ exit principles;
- Alarm potential operating hazardous events;
- Manual operation of points;
- Record operating events and alarms (sufficient to reconstruct an incident);
- Blocking of tracks, signals/routes and points;
- Display of train numbers in stabling berths;
- Display alarm status; and



14.5.15.4 The major equipment of the depot signaling sub-system, is as follows:

- Mimic panel;
- Work stations (Operator and Engineer);
- Computer Based interlocking;
- Point machines;
- Signals. 2 aspect;
- Track circuits (AC-Immunised)

14.5.16 Signaling Plans

14.5.16.1 Schematic signaling for stations with points & crossings are shown in Fig 14.1 to 14.7 which are based on tentative Civil Engineering plans for those stations.

The proposed yard layout, track circuiting arrangements and the location of insulated rail joints etc. are tentative and signals and their locations as indicated are only conceptual. A schematic plan of the entire section including car shed is also shown in Fig 14.8 with EMU performance characteristic and track details indicated therein.

14.6 **Project Management**

14.6.1 A core team of experts with international exposure in similar projects with the support of local experts will be employed on the project. The scope of project management will include

- a. Contract and material management
- b. Project monitoring
- c. Preparation of designs and plans.
- d. Construction supervision and quality control.
- e. Certification and training of personnel for installation, maintenance and safety practice.
- f. Safety report of the project.
- g. Completion drawings and completion plans.

14.6.2 For execution of project, bid document will be prepared including BOQ, specifications, special conditions, safety requirements, quality control and health and hygiene for working personnel and good construction practices to be followed in the project.

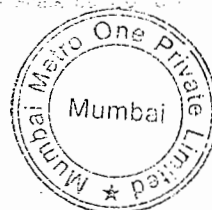

14.6.3 Requirement of materials including specifications, estimated rates pertaining to procurement schedule and inspection authorities will be identified and incorporated in the work plan.

14.6.4 Construction depots, storage space for materials etc. will be identified.

14.6.5 A System Requirement & Specification (SRS) will be framed which will be the starting point for Project Implementation. SRS will be framed in three parts:

- a. Project Implementation.
- b. Operation
- c. Maintenance

14.6.6 After identifying the detailed requirements and consolidating them in SRS, the same will be analysed and compared with the commercial products in the market. The level of customization will then be determined and the best possible mix will be selected.

14.6.7 A review of all ATP systems operational world wide will be made and the best proven cost effective system will be chosen bearing in mind the safety, reliability and availability of the system.

14.7 Construction Methodology

Detailed designing and implementation of various sub-systems will be done as under:

14.7.1 Designs & Drawings

14.7.1.1 Signaling & Communication activities start with the finalization of Engineering scale plans. The plans will be checked to see the Civil structures required for signal & telecom system are adequate.

14.7.1.2 Drawings & designs will be based on the Engineering scale plans & station design to suit the traffic, commercial, operation and maintenance requirements. An assessment of Civil requirements like service buildings, tower, duct for cabling and other structures will be done. Power requirement and their locations also will be analyzed. These activities will be carried out in close co-ordination with Civil & Electrical Engineers.



14.7.1.3 Detailed designing of signaling sub-systems will be basically preparation of a plan incorporating all requirements of interlocking keeping in view the structural constraints and flexibility of train operations.

14.7.1.4 As regards the communication systems, a detailed survey will be carried to identify the location of towers for Mobile Train Radio system. Similarly, a detailed cable route plan will have to be made for Optic Fibre cable.

14.7.1.5 All designing activities will duly include the requirements of future expansions to the extent it is possible and adequate provisions of expandability will be made.

14.7.2 Integrated Signal & Communication Systems

14.7.2.1 An integrated approach will be adopted for providing Signal & Communication. Systems as done in other Metro systems. Complete design of Integrated Signal & Telecom systems will then be prepared with necessary specifications for systems and special requirements.

14.7.3 Selection of Proven Systems

14.7.3.1 The best proven modern ATP system, Computer Based Interlocking, optic fibre system, train radio and electronic exchange etc. in the market being used in other similar Metro cities will be chosen for this project.

14.7.4 Mobilisation

14.7.4.1 For execution of the work qualified engineers and supervisors who have long experience in Railways for construction, operation and maintenance will be deployed.

14.7.4.2 Additional man power of engineers, supervisors, technicians and skilled workman will be recruited and trained by experts in the systems chosen. Enough manpower will be recruited for taking up the work simultaneously at different locations as required to complete the project within the target set. A separate set up will be made for procurement of systems and equipments so that they are available in time for the work.



14.7.5 Construction Depots

14.7.5.1 Construction Depots will be established at suitable locations for storing the construction equipments and also workshop for fabrication etc. for installation purpose.

14.7.6 Power requirement

14.7.6.1 After the designs are ready power requirement will be assessed and given to Electrical Engineers

14.7.7 Material requirement

14.7.7.1 Construction machinery and equipments required to carry out the work will be procured along with conveyance and transportation vehicles. All equipments based on the design and requirements, quantities of various equipment will be assessed and procured.

14.7.8 Progress of Work

14.7.8.1 Track side work and indoor work will be planned and progressed simultaneously as per availability of track, service buildings and structures from Civil Engineers.

14.7.8.2 Progress of work will be closely monitored and attempts will be made to complete the work well before target. Planning will be in such a way that some float period is kept for any slippage.

14.7.8.3 Tight supervision needed for installations of safety equipments will be provided. Workmanship of all the installations will be of high standard comparable to international standards.

14.7.8.4 A program of completion in the form of bar charts will be prepared and each activity will be monitored for effective management of the project.

14.7.9 Inspection & Testing

14.7.9.1 Inspection and testing of all the equipments and systems will be done at various stages of installation and kept ready for final testing and commissioning.



14.7.10 Safety Management

14.7.10.1 A safety management programme will be made and implemented at all stages of installation and a final safety management project report will be prepared and implemented.

14.7.11 Workshop

14.7.11.1 A state-of-the-art workshop for repair and maintenance facilities for all electronic equipment, point machines, signals, track circuits and other communication equipment will be set up with on line maintenance terminal for speedy maintenance, This will be in addition to all required test equipment, including track equipments for testing cab equipment before introduction into service.

14.7.12 Training

14.7.12.1 A training centre will be attached to the workshop with multimedia facilities for imparting training to the construction staff during all stages of construction testing and commissioning and also to the operating and maintenance staff for efficient operation and maintenance of the system.

14.8 Reliability of signaling system

14.8.1 The value of Wrong Side Failure less than 10^{-9} per train operating most international signaling suppliers like Alstom, Westinghouse, Alcatel, etc. The reliability figures for the signaling system and major components depend on the selected international supplier during project implementation and would be advised to MMRDA during detailed design.



CHAPTER – 15

COMMUNICATION SYSTEMS

15.1 Introduction

15.1.1 A state-of-the-art communication network connecting important locations like OCC, stations, depots, moving trains and staff working along Railway track is an essential requirement for efficient Railway Management and operation. To meet this requirement the communication systems shall provide highly reliable communication channels for carrying voice, data and video signals having compatibility with other systems on MRTS.

15.1.2 The communication systems shall cater to & provide optical based backbone for the following functions / systems:

1. Train control
2. Emergency control
3. Dedicated communication between stations
4. Telephone Exchange system
5. Maintenance control for various department
6. Centralised control system
7. Train designation indicator
8. Passenger announcement system and clocks
9. Telemetry system for power control & escalators
10. Instant on-line Radio communication between moving cars and OCC and maintenance personnel.
11. Data channels for signaling
12. Automatic fare collection system

15.1.3 The communication systems shall comprise the following:

1. Public Address System (PAS)
2. Passenger Information Display System (PIDS)
3. Closed Circuit Television (CCTV) System
4. Telephone System
5. Train Radio System
6. Master Clock System
7. Fibre Optic Transmission System (FOTS)
8. Trainborne Communication System

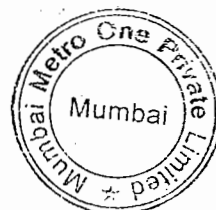

9. PA system will also be provided for the Depot
10. OCC will have the same flexibility as the Stations control; i.e. the ability to address selected stations, platforms, concourses etc
11. The trunk radio system proposed will be compatible to open, vendor-neutral standards such as Tetra.
12. The telephone and digital transmission system proposed are compatible to open, vendor-neutral standards

15.2 Public Address System (PAS)

15.2.1 The PA system (see Figure 15-1) is to allow the operators to make audio announcement to the passengers. PA audio and selection panel shall be provided at Operation Control Center (OCC), Station Control Room (SCR) for making live announcement to the selected PA zones. For OCC, the selectable PA zones shall include at least a selected station, a group of stations or all railway stations. For SCR, the selectable PA zones shall include at least each individual platform and concourse of its station. It is optional to have separate depot PA system but with audio and selection panel from the console of Depot Controller.



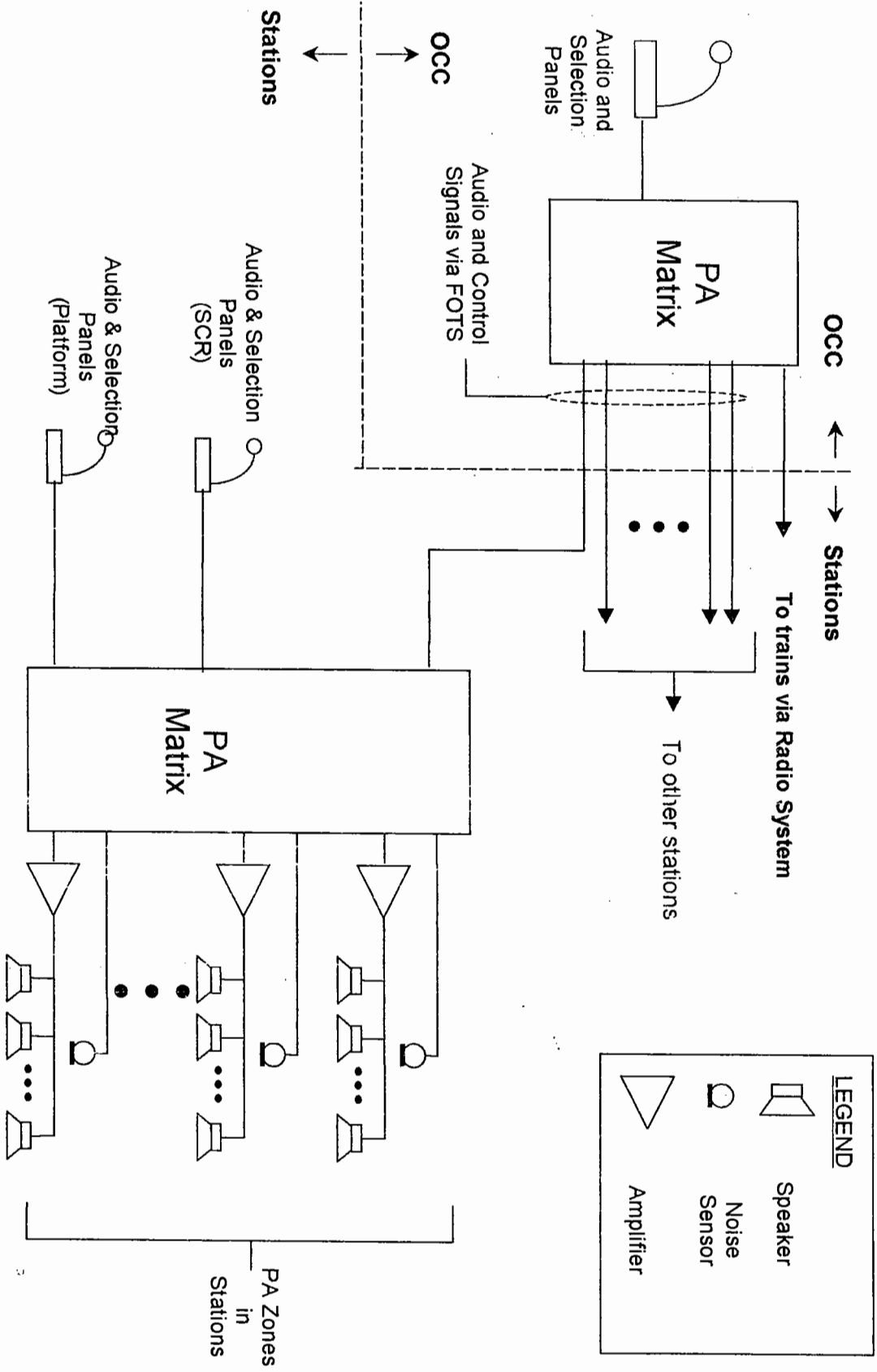
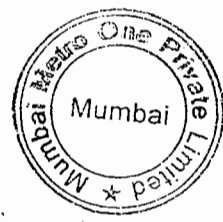
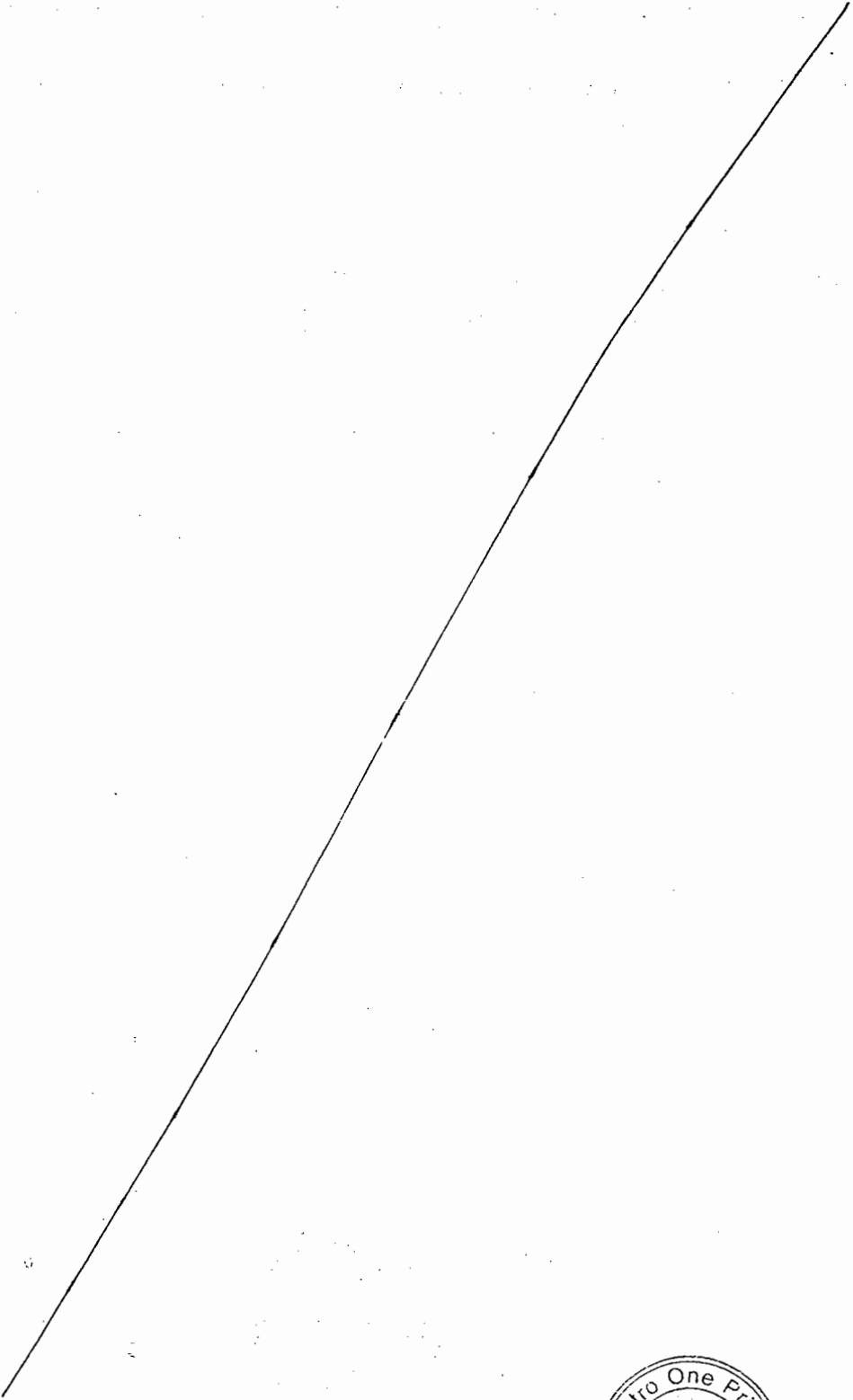

Figure 15-1: CONCEPTUAL DIAGRAM OF MRTS PUBLIC ADDRESS SYSTEM

Mass Rapid Transit System On Versova - Andheri - Ghatkopar Corridor





15.3 Passenger Information Display System (PIDS)

15.3.1 The PIDS (see Figure 15-2) is to allow the operators to dispatch visual information to the passengers. Workstation Controllers shall be provided at OCC and SCR (by Station Master) for at least sending information of the next two trains to the display boards at each direction. The train information to be displayed shall include the destinations of trains in both Marathi and English; and its departure time. The displayed destination shall be lit continuously while only the time will change. The display board shall be installed at each platform and other required areas. The board shall be made of super high glow LED which shall be visible clearly from 20m under ambient light of bright sunny day in shade.

15.3.2 The PIDS shall interface with the PA to synchronize the broadcasted station audio and visual messages. It is optional to have interface between PIDS and radio system if visual messages are required to send from OCC to train-borne PIDS.

15.3.3 The central PIS at OCC will be used to send message to selected stations passenger information display board via the station LAN of the OFTS or have provisional features to send messages to display boards of selected train via the data channel of the TETRA radio system.



PIDS at Concourse



PIDS inside Train



PIDS inside Train Compartment



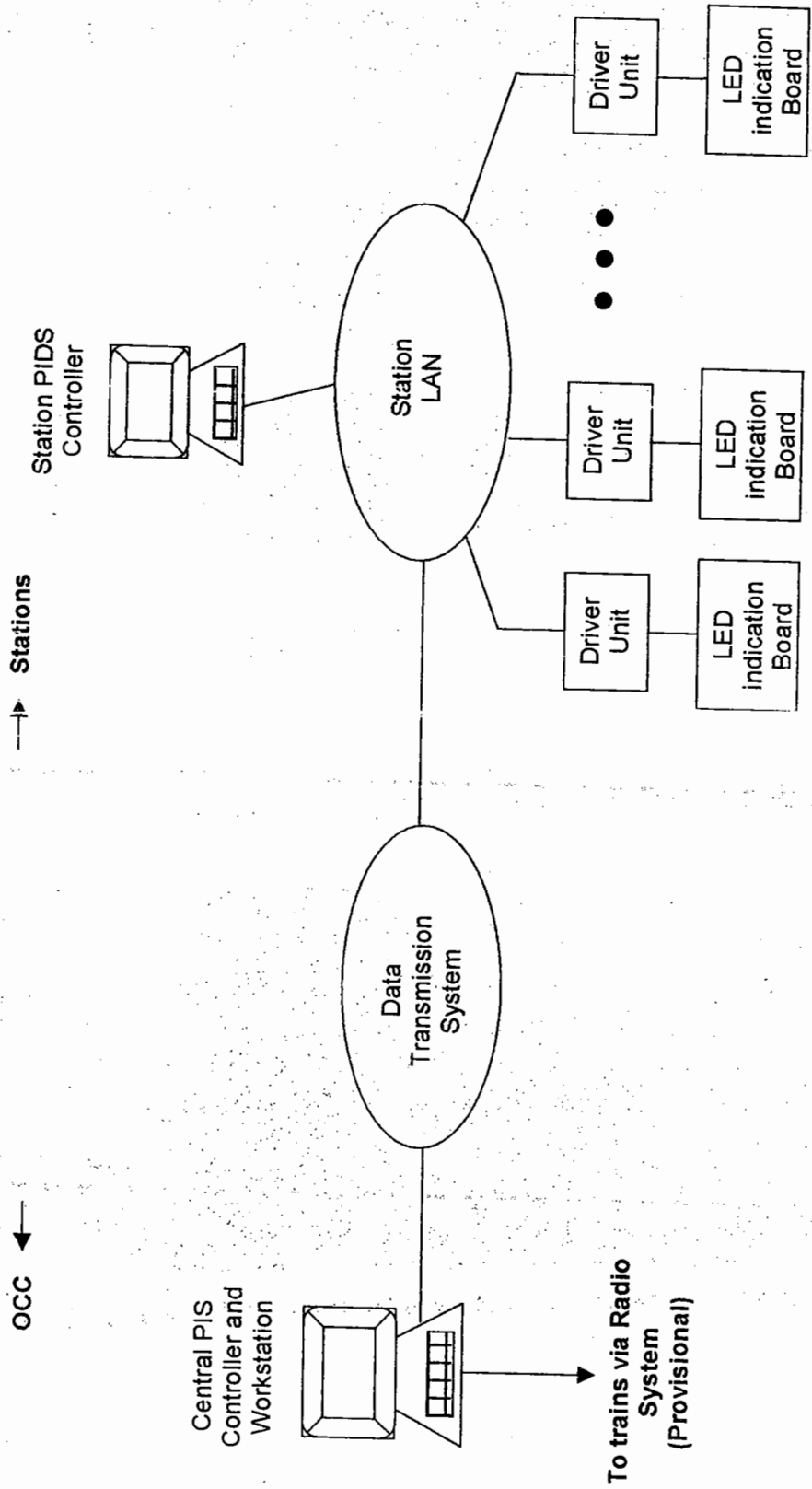
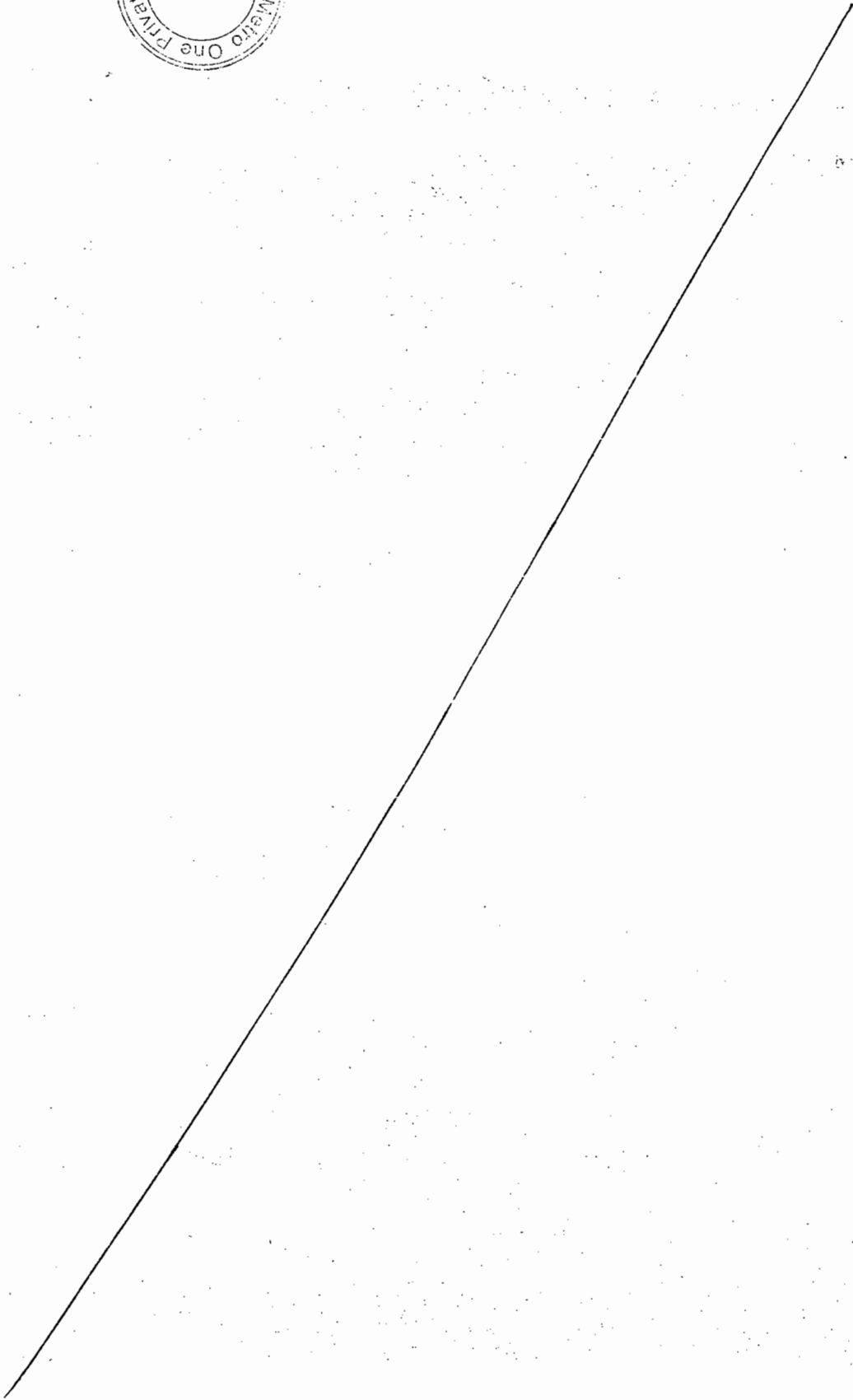

Figure 15-2: CONCEPTUAL DIAGRAM OF MRTS PASSENGER INFORMATION DISPLAY SYSTEM



15.4 Closed Circuit Television (CCTV) System

15.4.1 The CCTV system (see Figure 15-3) is to allow the operators to monitor to stations for security purpose. Fixed and pan-tilt-zoom types cameras will be installed at stations to be agreed with the designated engineer. CCTV monitors shall be provided at OCC, SCR and platform headwall. At OCC, a control panel shall be provided. The operators (Traffic Controller, Chief Controller and Engineering Controller) shall be able to select and monitor the required image from any station camera in either quad or full picture view by a control panel. At SCR, a control panel shall also be provided. The operator (Station Master) shall be able to select and monitor the required camera image from its own station in either quad or full picture view. At platform headwall, no control panel is required. The monitored camera image is fixed to its own platform cameras image in split screen format. It is optional to have video recorder for the camera images if required. It is optional to have separate depot CCTV system but with control panel and monitor at the console of Depot Controller.



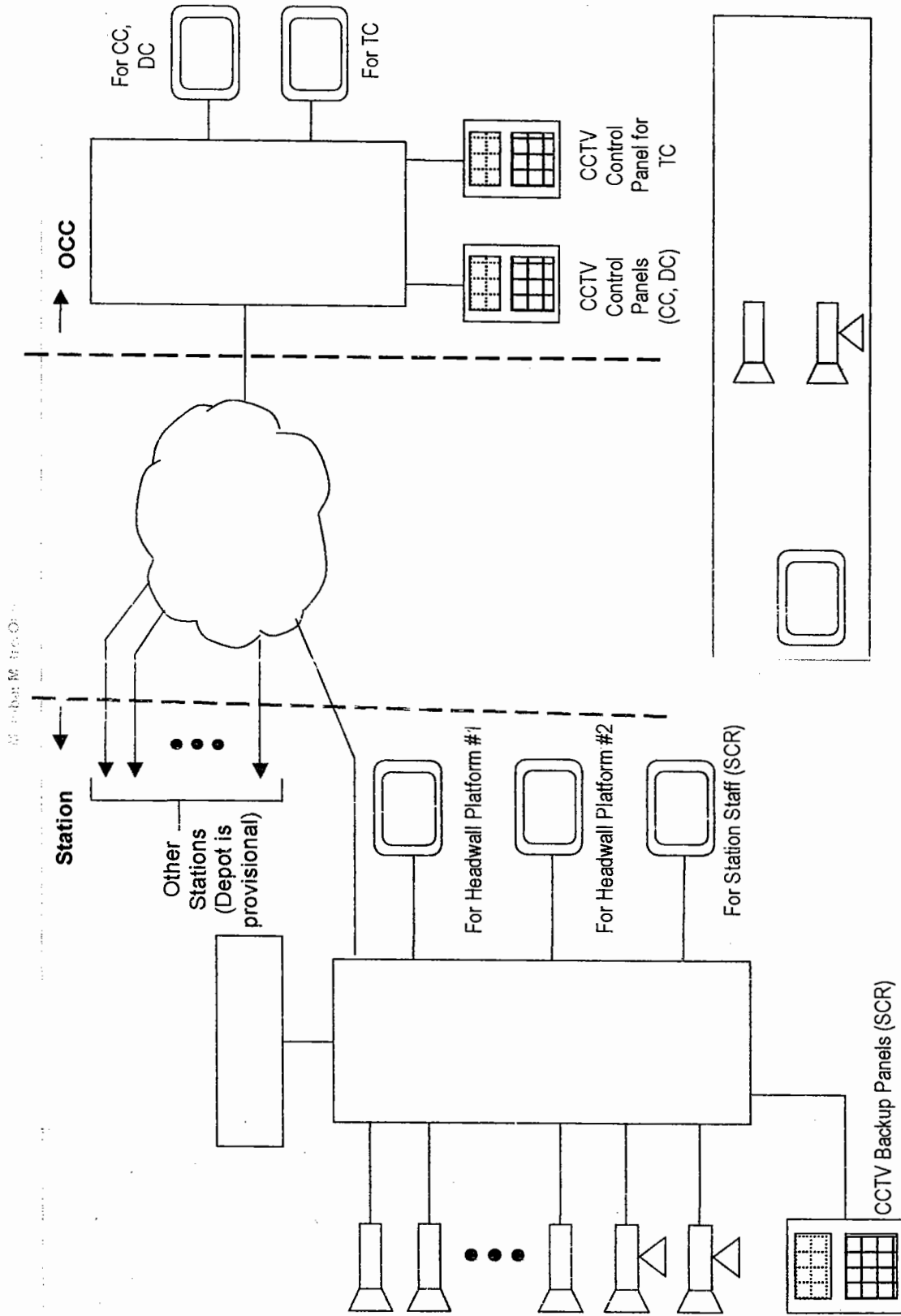

Figure 15-3: CONCEPTUAL DIAGRAM OF MRTS CLOSED CIRCUIT TELEVISION SYSTEM



15.5 Telephone System

15.5.1 The telephone exchange system (see Figure 15-4) shall consist of state-of-the-art, ISDN compatible, digital EPABX telephone network with following features:

1. Interconnectivity with Public Switched Telecom Network (PSTN), two way communication between passenger information points and staff operators at OCC/SCR
2. Call forwarding, call transfer, teleconference, conferencing voice mail, emergency override and call queuing.
3. It shall also have DECT facility
4. Modular construction for future expansion.
5. Interconnections at 2MB level.
6. Interface and compatibility with Radio system.
7. Centralised administration, maintenance attendant services and alarms etc.
8. Highly reliable system having various modules with high MTBF and low MTTR.

15.5.2 The EPABX will be installed at a central location and shall be equipped with trunk interface units. It shall have interface with radio system to enable radio users to initiate and receive calls from EPABX extension, or from PSTN telephone. The system will have facility of remote monitoring in addition to display of urgent/non urgent alarms, etc. at local end for ease of maintenance. It is optional to have a direct line non-blocking services be provided between OCC traffic controllers and stations designated locations.

15.5.3 The passenger information point (call point) at station will provide two way communication between passenger and staff operators at OCC/SCR. It will be a telephone set with a number of pre-programmed keys such that by pressing any one of these buttons will immediately connect to the destination.

15.5.4 The call point will equipment with device to assist disabled persons like induction loop for hearing-impaired passenger



Mumbai Metro One

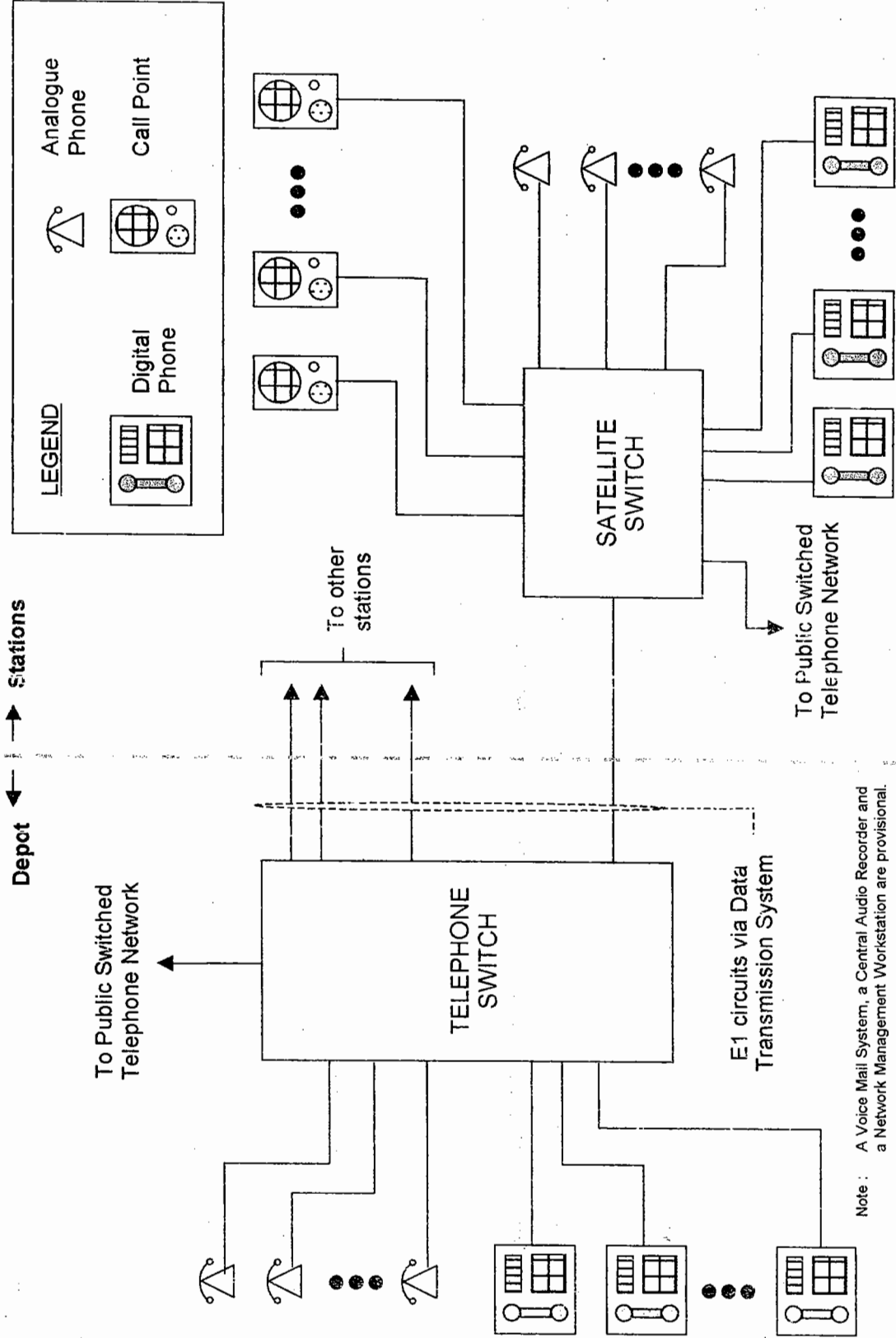
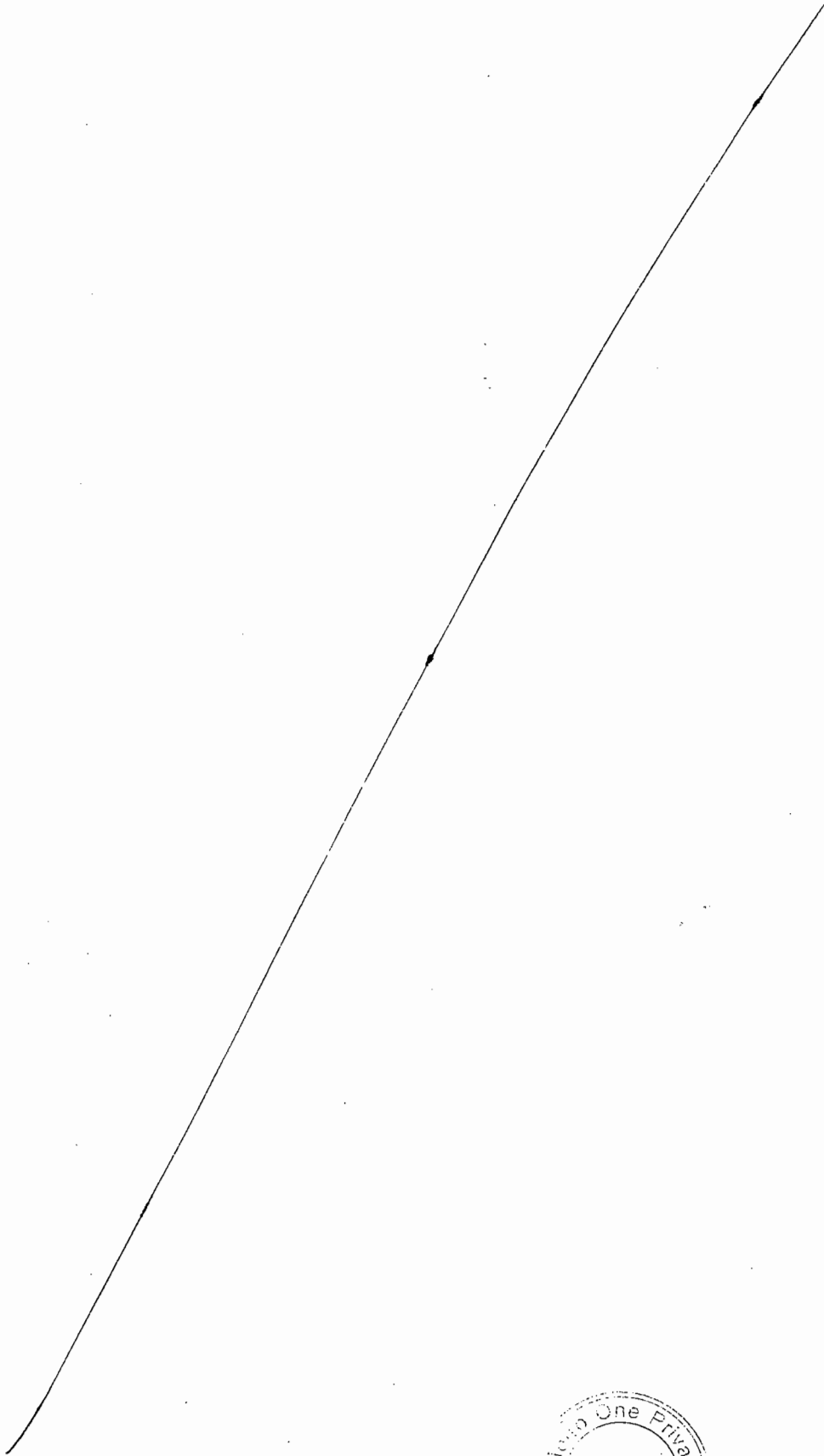

Figure 15-4: CONCEPTUAL DIAGRAM OF MRTS TELEPHONE SYSTEM



15.6 Train Radio System

15.6.1 Train Radio System (see Figure 15-5) for communication between driver, maintenance staff & controller is proposed to be used. It is based on open standard technologies (TETRA). This technology is being used extensively for communication on Railway network.

15.6.2 Telecommunications Standards Institute (ETSI). TETRA offers voice and data capabilities. Voice privacy, improved audio quality and improved spectrum efficiency are also common advantages.

15.6.3 It will use frequency in either the 400MHz or 800MHz band as granted by the Government Telecommunication Authority. 6 pairs of frequency will be used for communication with train radio and hand portable radio sets for operation, maintenance and security functions throughout the MRTS. It will provide:

- a) Instant 2-way communication between Controllers in OCC and train driver.
- b) Instant 2-way communication between designated controller and the maintenance/operating staff, working along the track and stations.
- c) Instant emergency communication.
- d) Communication between maintenance and operating staff, working within the depot area and depot controller.
- e) Radio system shall have the specifications, meeting functional and performance requirement of other similar corridors. The system shall have base stations, installed at selected locations to relay communication between all radios in the radio systems and shall be parented to central control equipment installed in OCC at DN Nagar. The location of base station shall be decided after detailed survey and shall provide adequate coverage. For stations at grade, tower mounted antenna will be provided to cover wide area. The radio system shall have suitable interface for integrating with other related sub-system. The system shall be capable to meet future requirement as well as up gradation.
- f) This shall also have feature of sending SMS for sending authority to driver maintenance staff. It shall have the feature of archiving data & voice.

15.6.4 Since TETRA can provide many call features and a wide range of user groups with efficient and intelligent communication. Several talk-groups will be configured in order to provide demarcation between different parties. For example, one independent talk-group can be assigned for the maintainer and station master at the sub section. One large talk-group can be assigned for the whole line stations so that a common channel is available for controllers in central control to dispatch information to all others at a time. Priority can be configured in a way that an established conversation of low priority would be overridden by a later but higher priority radio call request.



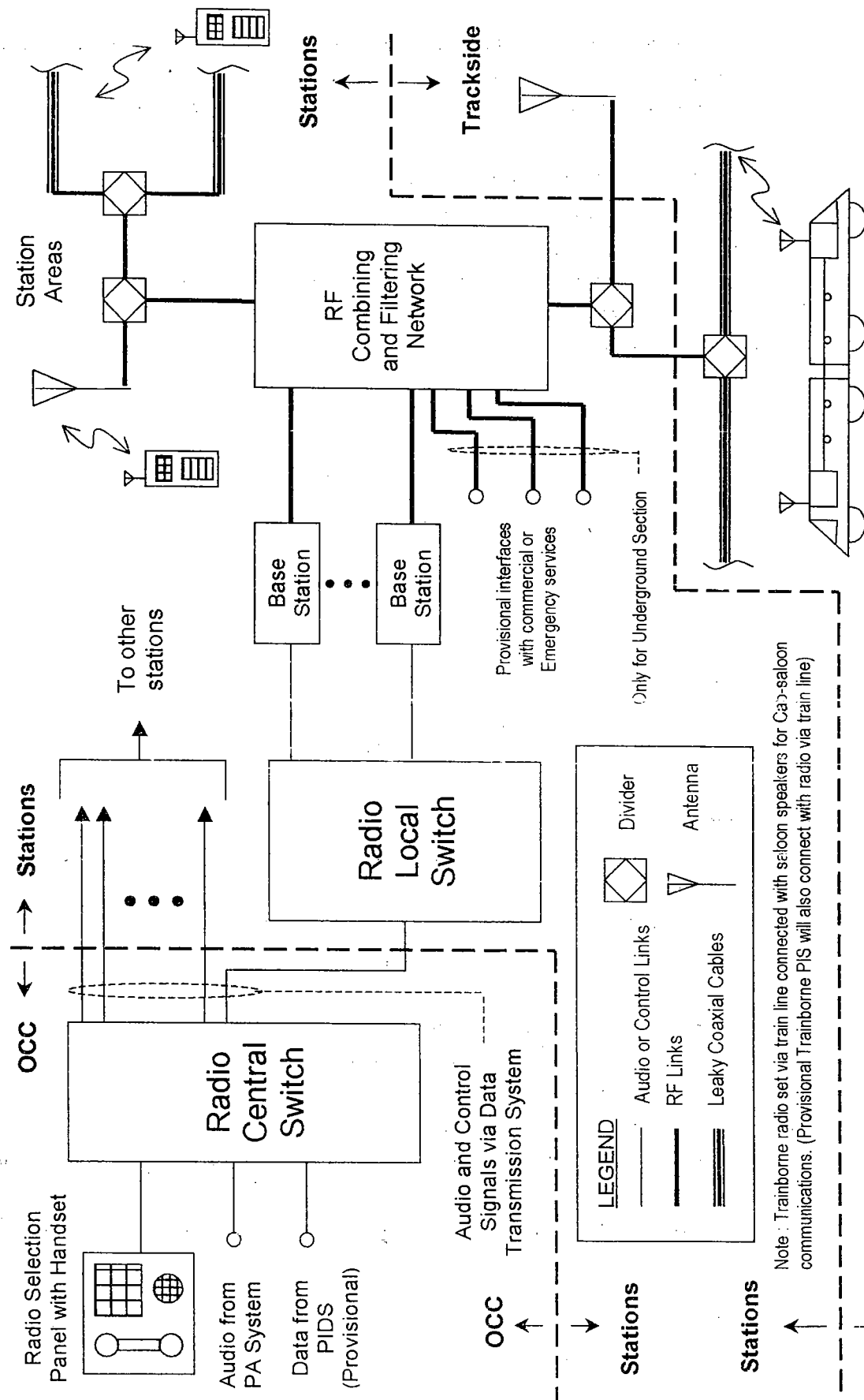

Figure 15-5: CONCEPTUAL DIAGRAM OF MRTS RADIO SYSTEM (STATIONS AND RUNNING LINES)



15.7 Master Clock System

- 15.7.1 The master clock system (see Figure 15-6) is to provide synchronized GPS clock signal and time signal for other equipment. Two master clocks run in parallel shall be provided at Central Control Building. One master clock is in working mode while the other is in hot standby mode. The master clock is a high precision synchronized clock. It shall be capable to drive up to 50 slave clocks directly within 2km distance. And a sub-master clock and slave clock shall respectively be provided at each operation area and station locations/work centre to be agreed by the designated engineer. The sub-master clock shall receive synchronize pulse in every 1 sec interval from the master clock. The slave clock shall display hour and minute only.
- 15.7.2 The sub-master clock shall interface with other system to provide synchronized time signal for other E&M system equipments if required.





Mumbai Metro One

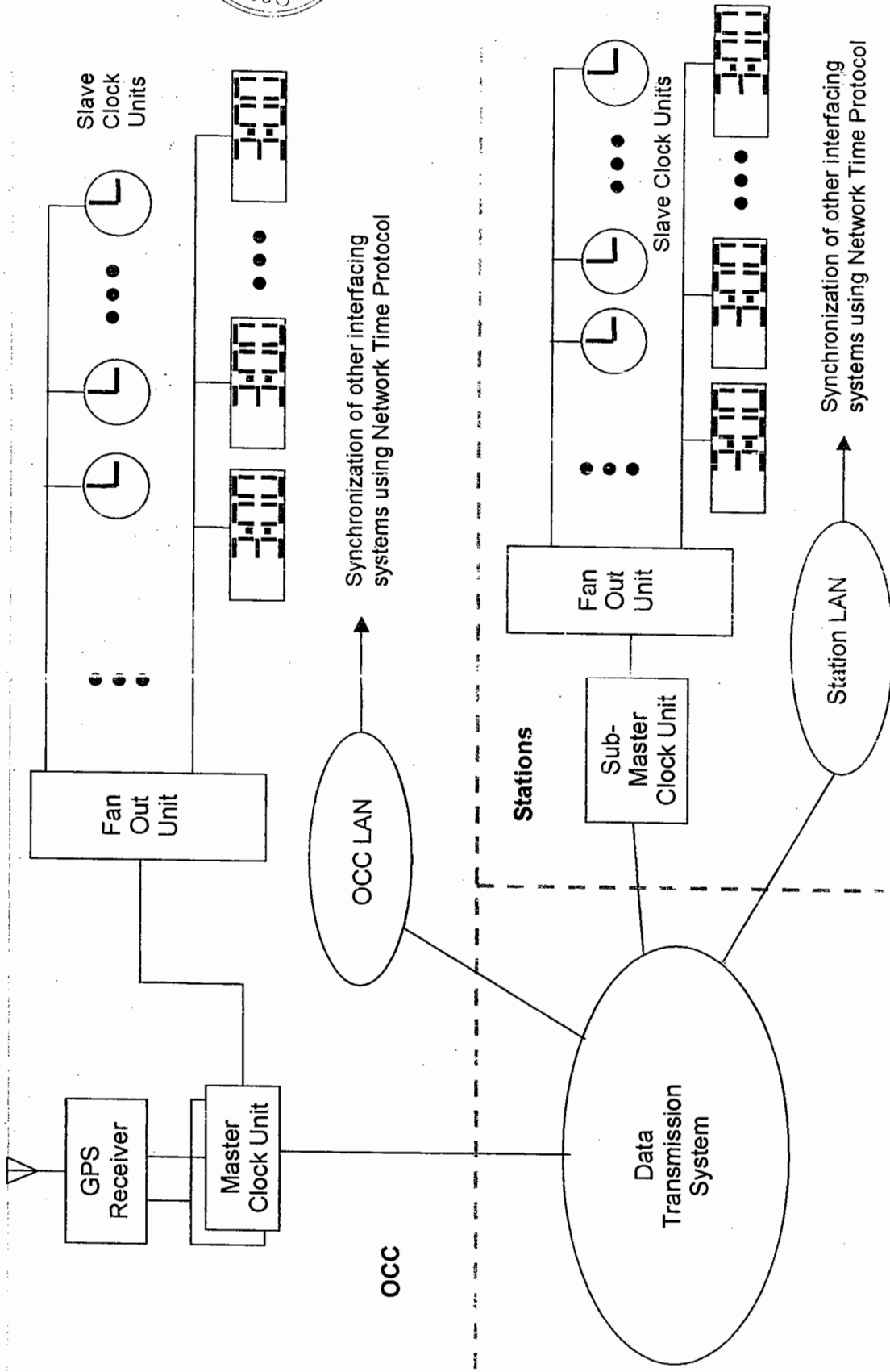
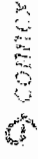

Figure 15-6: CONCEPTUAL DIAGRAM OF MRTS CLOCK SYSTEM



Reliance Energy
Mumbai



[A large, faint, illegible signature or stamp is present across the center of the page.]

15.8 Fibre Optic Transmission System (FOTS)

- 15.8.1 Optical fibre cable system (see Figure 15-7) shall be the backbone of telecom network. This shall provide sufficient transmission bandwidth to cater for requirement for voice, data and video signals for the corridor. The armoured optical fibre cable proposed is single mode type having 24 fibres with state of the art digital technology i.e. Synchronous Digital Hierarchy (SDH). The equipment proposed shall consist of STM-4 capacity – expandable to STM -16 with Network Management System (NMS) to monitor the status as well as control the operation. The NMS system provided shall have centralized and remote control for entire fibre optic telecom system including SDH equipment at terminal, regenerative repeaters and dropping station. The system will have compatibility with radio systems as well as with telephone systems.
- 15.8.2 The optical fibre cable is proposed to be laid on both sides of the track in order to have path diversity, forming a self healing ring to take care of any interruption in the cable. The SDH equipment i.e. STM -1 is proposed in 1+1 configuration to cater for any equipment failure for providing reliable communication. An additional OF cable between OCC and DN Nagar station will be provided for communication with OCC.
- 15.8.3 The FOTS shall be equipped with a Network Management System to provide status monitoring, configuration, analysis and control of various network elements.
- 15.8.4 The FOTS shall be highly reliable transmission system with availability of circuit at 2 MBPS level, better than 99.99% and circuit below 2 MBPS level better than 99.95%. The SDH equipment for the system shall have high MTBF and low MTTR, confirming to ITU standard.



CHAPTER - 16

AUTOMATIC FARE COLLECTION (AFC) SYSTEM

16.1 Introduction

16.1.1 The proposed automatic fare collection (AFC) system for MRTS will be a closed system which has controlled entry and controlled exit to and from paid areas using AFC gates. Fare media are read, encoded and verified by the gate's ticket processor. They are checked for authentication, blacklist, and validity, balance, ticket type, fare deduction and etc. If the validation is successful the gate will unlock the barrier allowing the passenger to pass through, otherwise will instruct the passenger to seek for assistance from Ticket Office.

16.1.2 AFC system will consist of a number of subsystems, which primary take care of fare collection, system and revenue data management. The system will provide a complete fare collection facility, which includes:

- (a) Collection and accounting of fares
- (b) Reduce fare evasion by controlling passengers and staff movement between the paid and unpaid areas within the railway under various situations, e.g. normal operation, incident, train delay, emergency, etc.
- (c) Automatic ticket issuing with exchange for cash payment
- (d) Fare media management
- (e) Examination and collection of ticket after use
- (f) Customer service for ticket enquiry, excess fare, add value, etc
- (g) Circulation, collection and control of cash
- (h) Recording and provision of information for use by the railway management

16.1.3 As requested in the bidding document, an overview and general requirements for the



proposed AFC System is included in the bidding proposal. Subject to further review and clarification, a more comprehensive proposal with detailed technical and functional requirements will be submitted in the design stage.

16.1.4 Spares will be provided on the basis of one additional set per array or 10%. Token will be considered for single journeys.

16.2 Fare System

16.2.1 Fare Structure

16.2.1.1 The AFC fare system shall support fare structure based on distance, zone, time of day, ride and period. Fare policy shall be flexible and be able to change frequently. Advanced fare media such as contact less smart cards shall be required to implement complicated fare policy and promotional programme, e.g. concessionary fares, loyalty scheme and various types of discount.

16.2.2 Ticket Type

16.2.2.1 The ticket system shall be a combination of some or all of the following ticket types, depending on the business needs and marketing strategies:

- (a) Single ride ticket
- (b) Multi-ride ticket
- (c) Stored value ticket
- (d) Period pass (unlimited ride within certain period)
- (e) Staff pass
- (f) Tourist ticket
- (g) Promotional ticket
- (h) Maintenance/Testing ticket



16.2.3 Fare Media

16.2.3.1 The function of the fare media is to contain encoded information that, when read by AFC gates, will permit passengers to enter or leave the system. Two major fare media shall be considered:

- (a) Contact less Smart Media
 - (i) Stored value ticket
 - (ii) Reusable token for single journeys
 - (iii) Disposable paper smart card
- (b) Plastic Magnetic Ticket
 - (i) Stored value ticket
 - (ii) Reusable plastic ticket for single or multiple journeys
 - (iii) Disposable paper magnetic ticket

16.2.3.2 It is proposed to use contact less smart media as stored value tickets and plastic magnetic media as single journey tickets.

16.2.4 Stored Value Ticket Management

16.2.4.1 Each stored value ticket will go through the following process:

- (a) Initialization – basic card information is written into the ticket, e.g. security key and threshold value.
- (b) Issue/Distribution – during the issuing process, some common system data is recorded into the tickets' memory.
- (c) Vending - during the vending process the tickets are registered into the central database and loaded with value. Stored value tickets can be sold with various pre-determined values.



- (d) Validation - tickets will be read, encoded and verified by the card readers which are mounted on the gate. The entry gates will check and validate the tickets. The exit gates will check the tickets' validity, station of entry, etc and deduct appropriate fare from the tickets.
- (e) Enquiry - passengers are allowed to check the remaining value, recent transactions and expiry date of their tickets.

16.3 System Description

16.3.1 System Architecture

The system can be divided into following levels:

- (a) Level 4 - Central Clearing House System (CCHS)
- (b) Level 3 - Central computer system (CCS)
- (c) Level 2 - Station computer system (SCS)
- (d) Level 1 - Station front end equipment



Mumbai Metro O & M

16.3.2 System Diagram

Level 4



Level 3

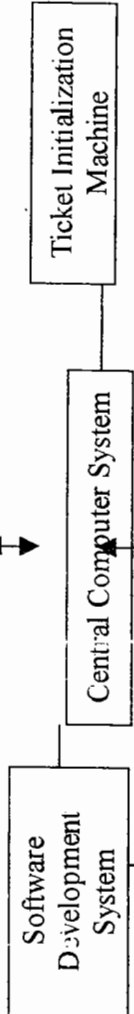

Level 2

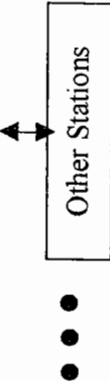

Level 1

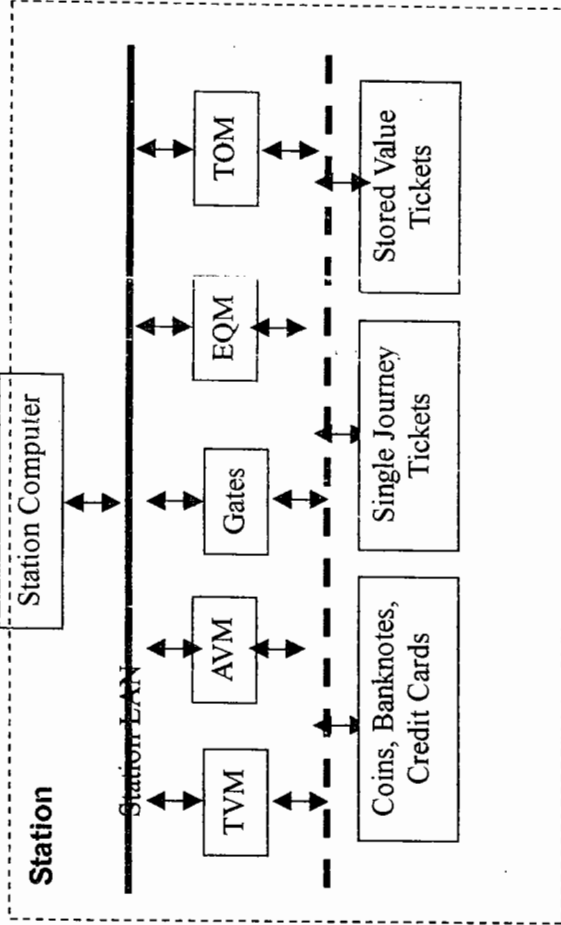

16.3.3 Level 1 – Front End Equipment

Front end equipments shall perform the following functions:

- (a) Ticket sales
- (b) Customer service, e.g. refund, add value, enquiry, etc
- (c) Ticket inspection, checking and validation
- (d) Cash handling

Besides, system equipment such as gates, TVM and AVM, should have audit functions, and the audit registers should be accessible from the network. All the operation and events should be logged

16.3.3.1 AFC Gates

- (a) The AFC gates shall be used to control the movement of passengers between the paid and unpaid areas of station concourse.
- (b) In order to pass through an AFC gate aisle, a passenger must present a ticket (fare media) for validity check. If the fare media is valid, then the gate barrier will be released allowing the passenger to pass through. If the fare media is not valid, the barrier will remain locked (closed). The barrier shall be either a turnstile or scissor type.
- (c) To assist passengers in using the AFC gates audio-visual graphic technology shall be incorporated in the gate design.
- (d) Gate type

Major gate types shall include the following:

- (i) Regular entry gate
- (ii) Regular exit gate
- (iii) Reversible gate



- (iv) Bi-direction wide gate (for wheel chair / large luggage)
- (e) Dimensions and Aisle Width (subject to further ergonomic study)

Suggested gate stanchion dimensions:

- (i) Length: 2000mm
- (ii) Width: 250mm
- (iii) Height: 1040mm

Aisle Width:

- (i) 500mm (minimum for regular aisle)
- (ii) 900mm (minimum for wide aisle)

16.3.3.2 Ticket Vending Machine (TVM)

TVMs installed in the unpaid area shall be used to dispense single ride tickets, e.g. magnetic tickets, CSC tokens/cards, etc. TVMs can accept coins and banknotes for payment. To make the TVMs easy to use audio-visual graphic and touch screen technology shall be incorporated in the TVM/AVM design.

16.3.3.3 Add Value Machine (AVM)

Stored value tickets can be recharged at any Add Value Machine or Ticket Office.

16.3.3.4 Enquiry Machine (EQM)

The Enquiry Machine (EQM) shall allow passengers to check on their fare media the remaining value, the most recent transactions and the expiry date.

16.3.3.5 Ticket Office Machine (TOM)



Ticket Office Machines shall be provided in the Ticket Office for ticket issue, analysis and validating.

16.3.3.6 Portable Ticket Analyzer (PTA)

PTA shall be self-contained, hand-held devices for smart card/ magnetic ticket inspection.

16.3.3.7 Encoder/Sorter (E/S)

The E/S shall be provided (for magnetic ticket only) at ticket centre for sorting mixed magnetic tickets collected into categories for recycling.

16.3.4 Level 2 – Station Computer System (SCS)

16.3.4.1 The SCS monitors and controls the AFC equipment on a station, keeping records of AFC transactions and audit data. Commands for the AFC equipment are sent to all AFC front end equipment covered by the scope of the command. Status and fault data received from the front end equipment shall be logged by the SCS.

16.3.4.2 All station AFC equipments report their information to the SCS. Every time an event involving ticket purchase or a passenger passing through a gate occurs, the SCS is informed. These events are reported to the SCS as transactions. All the transaction information on these passenger activities is then compiled into various Reports by the SCS on a regular basis. These reports may be printed locally or sent to the Central Computer System.

16.3.4.3 The SCS shall receive from CCS the necessary application file, operation data, e.g. fare table, blacklists of ticket, and disseminate to the front end equipment.

16.3.5 Level 3 Equipment

16.3.5.1 Central Computer System (CCS)

The CCS is a group of central computing resources that allow the operator's AFC system at the station to be centrally controlled and administered. The system shall provide the following main functions.



- (a) Ticket management
- (b) Revenue management and accounting
- (c) Usage data management
- (d) Station AFC equipment control and monitoring
- (e) Security key management
- (f) User and security management
- (g) System management - status monitoring
- (h) Production of AFC system reports
- (i) Passenger flow monitoring

16.3.5.2 Ticket Initialization Equipment

The Ticket Initialization Equipment shall encode ticket with primary information such as security ID and card expiry date. All card/ticket information will be registered at CCS for security monitoring. Tickets cannot be used in the system before initialization.

16.3.5.3 Software Development System (SDS)

The SDS shall provide the complete facility to develop all system software, including the firmware on each equipment. It shall comprise a code development subsystem and a simulation subsystem

16.3.6 Level 4 - Central Clearing House System (CCHS)

16.3.6.1 CCHS is optional if the tickets or AFC system is only used by a single service provider, i.e. a single railway operator. However, interface to this system will be incorporated in the AFC system for future development if required.

If more than one services provider are involved in the same ticketing system, a central clearing system is inevitable. All transaction data shall be transmitted to the CCHS for reconciliation and settlement of revenue between services provides within 24 hours. Ticket transactions shall consist of ticket sale, ticket usage and add value transactions. The settlement is based on the fare and transaction information received from all service providers involved.

16.3.6.2 Functions of CCHS

CCHS shall consist of several subsystems to perform of the following major functions:



- (a) Device management
- (b) Services provider management
- (c) Clearing and settlement
- (d) Billing
- (e) Transaction process and management
- (f) Blacklisting
- (g) Card management
- (h) Audit and reconciliation
- (i) System and security key management

16.4 Equipment Layout

16.4.1 A closed system requires more stringent passenger handling ability for AFC equipment. AFC equipment layout should, where possible, enable a smooth circulation of passengers across the station concourse. The design will take into account the peak passenger flow and concourse space available. In principle, AFC equipment should be placed along the normal path of passengers, thereby reducing the effect on the flow of passengers and minimizing the inter-crossing of passenger flows.

16.4.2 Gates

16.4.2.1 The entry gates and exit gates define the boundary between the paid area and unpaid area.

16.4.2.2 Manually and automatically operated emergency exits should be located at the end of the lines of major gates. In case of emergency, the emergency exits should open automatically, enabling efficient evacuation.

16.4.2.3 The entry and exit of passengers with special needs should be considered, for example disabled passengers and passengers with large baggage. Wide gates or emergency exits can be used in such occasions.

16.4.2.4 The quantity of AFC equipment will be calculated according to the peak passenger flow, service level, concourse layout, equipment availability and evacuation time during emergency. The evacuation capacity depends on the maximum possible number of passengers, including the passengers in the station and on the trains.

16.4.2.5 The location of entry gates should match those of the other equipment, such as TVM and AVM.



16.4.2.6 The gates should be positioned in such a way that they go with the escalators, staircases and other pathways, providing passengers with the greatest convenience.

16.4.2.7 Buffering areas should be reserved at both sides of the gates to cater for situations in which passengers queue up for passing the gates, or queue up for escalators after passing the gates.

16.4.2.8 The positioning of the gates should maximize the paid area.

16.4.2.9 For stations with comparable entry and exit passenger capacity, groups of entry gates and exit gates should be separated. Unidirectional gates are recommended in such circumstances.

16.4.2.10 Some stations might have special passenger capacity characteristics, for example the entry and exit passenger capacities differ a lot between the morning and evening peak hours. Groups of entry gates and exit gates should be located adjacent to each other. Reversible gates should be employed, allowing more flexibility in handling the passenger flow.

16.4.3 TVM and AVM

16.4.3.1 The TVM and AVM should be located along the major paths of passengers.

16.4.3.2 The quantity of these equipment mainly depend on their usage by passengers, service level and equipment availability.

16.5 Station Operation

16.5.1 The AFC System Operating Modes shall cover normal and emergency operations, and condition requiring full or partial waive of fares such as train service disruption. The system design shall also cater for station evacuation within minimum time as required by local regulation.

16.5.2 Operation modes shall include, but not limited to, the following: normal mode, out of service mode, maintenance mode and degraded mode. The mode switch should be initiated by commands from CCS or SCS, system configuration parameters or the equipment itself.

16.6 Security

16.6.1 Security issues are crucial to the AFC system. Security measures shall cover but not limited to



the following:

16.6.1.1 Revenue Protection

- (a) All revenue sensitive modules should be secured.
- (b) AFC machines and fare media shall resist against tampering by both customers and unauthorized staff.
- (c) Audit register values, which are used for revenue reconciliation and checking, cannot be altered or reset.
- (d) The system shall provide a complete audit trail of all transactions.
- (e) Data shall not be lost due to failure of equipment and transmission medium. The system shall be able to perform self-recovery after system failure.

16.6.1.2 Data Security

To ensure data security, the following actions should be done:

- (a) Authentication with the CCS (based on cryptographic keys) is performed cyclically.
- (b) Authentication between the ticket/card reader/writer and fare media is performed systematically. Cryptographic keys are stored securely within a cryptographic module to prevent disclosure.
- (c) Usage data is uploaded to the CCS at regular intervals.
- (d) All sensitive data is stored in the database which is accessible only by authorized application.
- (e) Files and data received from or sent to the Central System are signed in order to verify the sender.
- (f) Data integrity can be ensured using security measures such as MAC (Message Authentication Code).



16.6.1.3 Network Security

- (a) AFC LAN shall be based on TCP/IP and Ethernet standard. Access from outside the network shall be controlled by Firewalls and Authentication.
- (b) All the files and data sent through the transmission medium are encrypted to protect against eavesdroppers.
- (c) The combination of IP filtering and authentication protocol should defeat most attempts of intrusions. Auditing facilities keep track of such attempt of intrusions.

16.7 Design Principles

16.7.1 Human Factors

16.7.1.1 The principles of human factors engineering shall be applied throughout the design to facilitate ease of use and safety for passengers, operators and equipment.

16.7.1.2 AFC equipment shall be so designed that it will fit for use in the environment to which it is deployed.

16.7.3 Facilities for Disabled

16.7.3.1 At least one wide aisle shall be provided at each station/concourse.

16.7.3.2 Audio/video graphic technology to help wheel chaired and handicap to work through the system.

16.7.3.3 "Call for assistance" button to transmit a signal to the SCS to indicate the passenger in need of assistance from the station staff.

16.8 Standards

16.8.1 Fire Safety (Fixed Guideway) - American National Standards, National Fire Protection Association (NFPA)

16.8.2 Magnetic properties - High Coercivity Ticket Specification



16.8.3 Contactless Smart Card/Token - ISO 14443 Type A, Type B or Type C

16.8.4 Ticket/Card – ISO 7816

16.8.5 AFC LAN – IEEE 802.3 CSMA/CD

16.8.6 Equipment Enclosure - IP54CS



APPENDIX A - FARE MEDIA OPTIONS

A1. Magnetic ticket

A1.1 Magnetic tickets have been widely used as a fare media for many years, and continue to be implemented in various transit systems worldwide. This type of system is welcomed for its simplicity and low cost of tickets.

A1.2 However, the development of this technology is still bounded by its shortcomings. The mechanical modules used for handling magnetic cards inside the AFC equipments are very expensive (the price of each unit is about one third of the unit gate price) and require frequent maintenance. Moreover, as quite a number of mechanical operations are performed on the ticket in each transaction, the overall processing time for magnetic tickets is relatively long. As a result, additional equipments are needed.

A1.3 The associated Ender/Sorter machines are extremely expensive and usually unreliable which require frequent maintenance.

A2. Contactless Smart Card (CSC)

A2.1 Contactless electronic payment method is more economical than magnetic ticket system in the long run. It also reduces the amount of cash circulation in the railway system. The use of a fully contactless AFC system significantly reduces maintenance costs as well.

Advantages of contactless solution:

- (a) Fast collection of fares
- (b) Simplicity of operation
- (c) More reliable and robust
- (d) Multi-functionality (period pass, free pass, electronic purse, etc)
- (e) More revenue secure
- (f) More flexible fare structure
- (g) Possibility of usage outside transport, e.g. security access, parking fees, identification (student ID card), retail purchase, etc – opportunities to generate non-fare revenue.



A2.2 Card Type

Contactless Smart Cards can be used as period, stored value and multi-ride tickets. For non-stored value cards, e.g. single/return journey tickets, lower cost smart tokens or disposable cards can be considered. The choice of the card type, e.g. paper ticket, token, etc, is subject to the following considerations:

- (a) Ticket price
- (b) Operational cost
- (c) Environmental friendliness
- (d) System type (open or close)
- (e) Ticket recycling method to be adopted

A2.3 Multi Application

In order to enhance the popularity of the CSC system among customers, the system can be upgraded for other applications, including other modes of transport and non-transport applications such as retail. It should also allow individual operators to have their own fare structures and promotional programs.

For example, a tourist card at a fixed fee based upon length of stay enabling free entry to attractions such as museums, and use other public transports that are included in the scheme.



APPENDIX B – RECYCLING OPTIONS FOR SINGLE RIDE (SMART MEDIA) TICKET

B1. Option 1

In this option single ride tickets will not be collected at exit (from paid area), but the passenger have to pay an extra fare as deposit when buying the ticket. The used card could be either reused by being recharged at TVM/ticket office, or refund at ticket office. This option causes inconvenience to the passengers.

B2. Option 2

Single ride ticket will be collected at exit when the journey finished. The exit gate design will be very complicated and expensive.



APPENDIX C – AFC GATE OPTIONS

AFC gate can be classified into three main types namely turnstile, flap and scissors types. It shall take into consideration for the choice of gate type the safety, revenue security and throughput capacity.

Item to consider	Turnstile	Flap	Scissors
Revenue security	H	M	H-M
Safety	M	M	M
Maximum Throughput (PPM)	35	70	70
Convenience	M	H	H
Space required	L	M	M

H: High, M: Medium, L: Low



Appendix D – Reference Photos



Passenger Gate

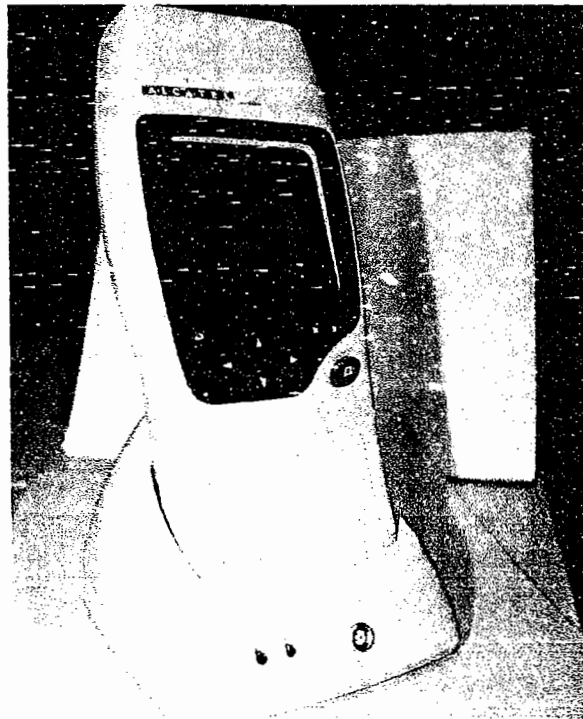

Portable Ticket Analyser (=PCA)





Reader (=MPR)

Ticket

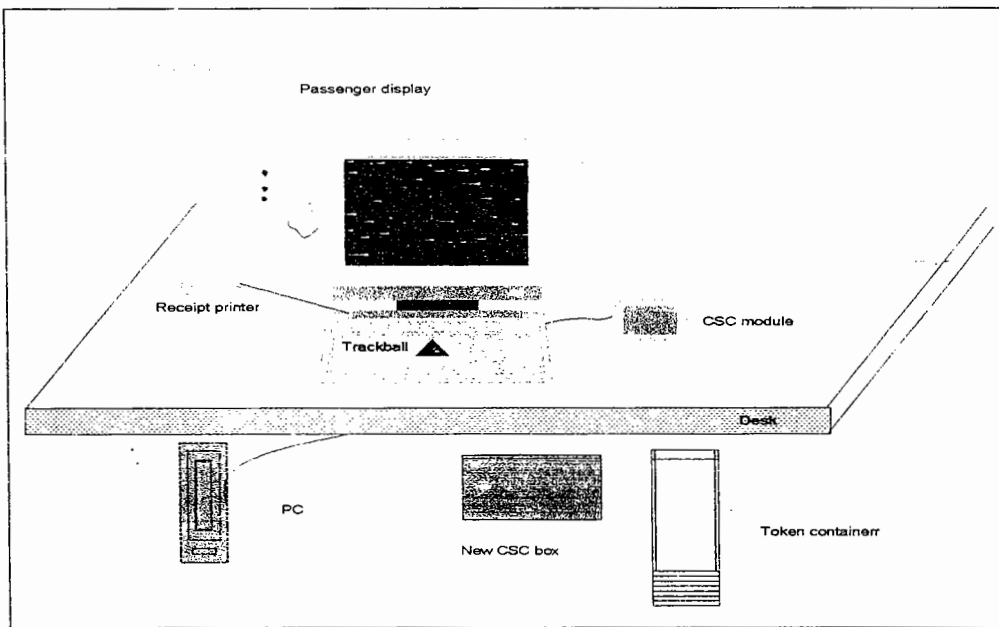

Ticket Office Machine (=OCP)



CHAPTER 17

OPERATION CONTROL CENTRE (OCC) FACILITIES

17.1 Operating Functions

17.1.1 The Operations Central Control (OCC) building is to be located inside Depot at DN Nagar. OCC staff is responsible for:

- management of safe working of people for track access and HV power
- entry and exit of trains between Depot area and the running line
- the regulation of train in the running line
- the monitoring and control of the traction power supply system
- the regulation of train inside the depot
- management of normal and abnormal working of the metro system
- management of minor emergency and coordination of major emergency incidents with the civil authorities
- communications with public and passengers

17.2 OCC Staffing

17.2.1 It is assumed that the OCC is staffed by the following operators:

17.2.1.1 Chief Controller who manages emergency incidents, normal and abnormal operations of the transit system via the OCC systems equipment, operating rules and procedures. The Chief Controller shall be able to interrogate the central control facilities (ATS, SCADA, Comm) for reporting purpose.

17.2.1.2 Two Traffic Controllers who are responsible to regulate passenger train services and work trains in the running line, via Signalling System.

17.2.1.3 Engineering Controller who is responsible for the supervision of the Traction Power System; configure the traction power sections for service and maintenance requirements;

17.2.1.4 Depot Traffic Controller who is responsible for the regulation of train inside the depot and coordinate with the maintenance organization for preparation of trains for entry to revenue service.

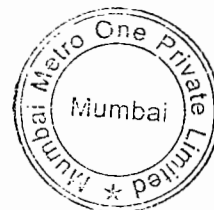

17.3 SYSTEM AND EQUIPMENT

17.3.1 Chief Controller shall be provided with an operator console equipped as follows:

- SCADA operator workstation
- SIG operator workstation
- Radio communications panel
- Telephone panel
- CCTV monitor and control panel
- PA audio selection panel
- Passenger Information System (PIS) operator workstation

17.3.2 Traffic Controllers and Depot Traffic Controller shall be provided with operator console equipped as follows :

- SIG operator workstation
- Radio communication panel
- Telephone panel
- CCTV monitor and control panel

17.3.3 Engineering Controller shall be provided with an operator console equipped as follows:

- SCADA operator workstation
- Radio communication panel
- Telephone panel

17.3.4 There shall be separate Mimic displays for Signaling and SCADA system.

17.3.5 The following equipment shall be provided for shared use by all OCC operators:

- Office furniture
- printers



- scanner
- photocopier
- Fax machine
- File cabinets

17.3.6 All the operator consoles shall be ergonomically designed to suit the local anthropometric data.

--	--	--	--

17.3.7 All operator consoles shall be designed and provided by the same suppliers for consistency purpose.

17.3.8 The room layout design of the OCC shall be ergonomically design taking into account the communications/interaction among different operators, the room physical constraints and the viewing angle from the operator position to the mimic display. Typical OCC layout are attached for reference (Fig.17.1, 17.2, 17.3).



Fig. 17.1 - CONCEPTUAL DIAGRAM OF MRTS OCC FACILITIES

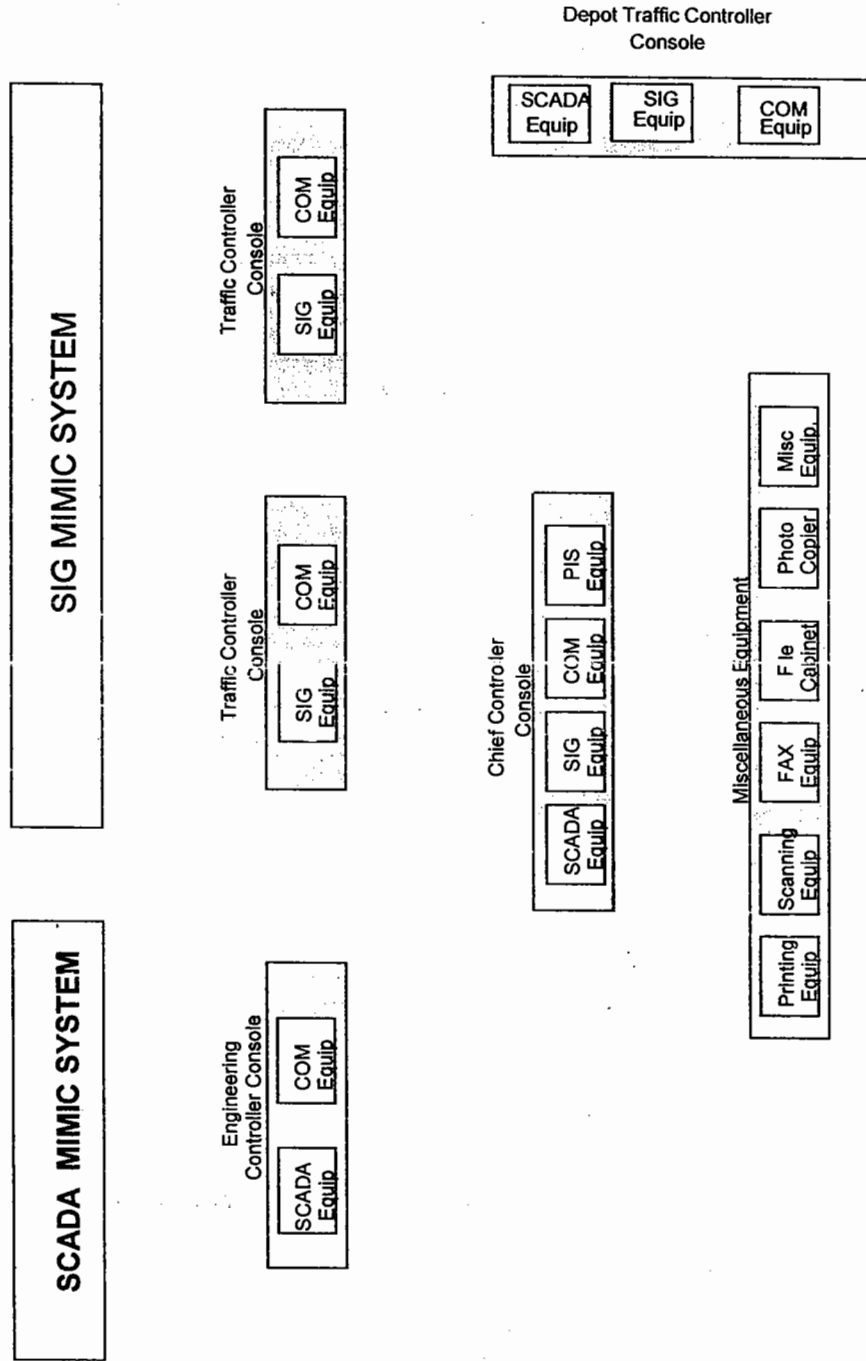

Fig. 17.2 - Computer Simulation of Typical OCC (3-D View 1)

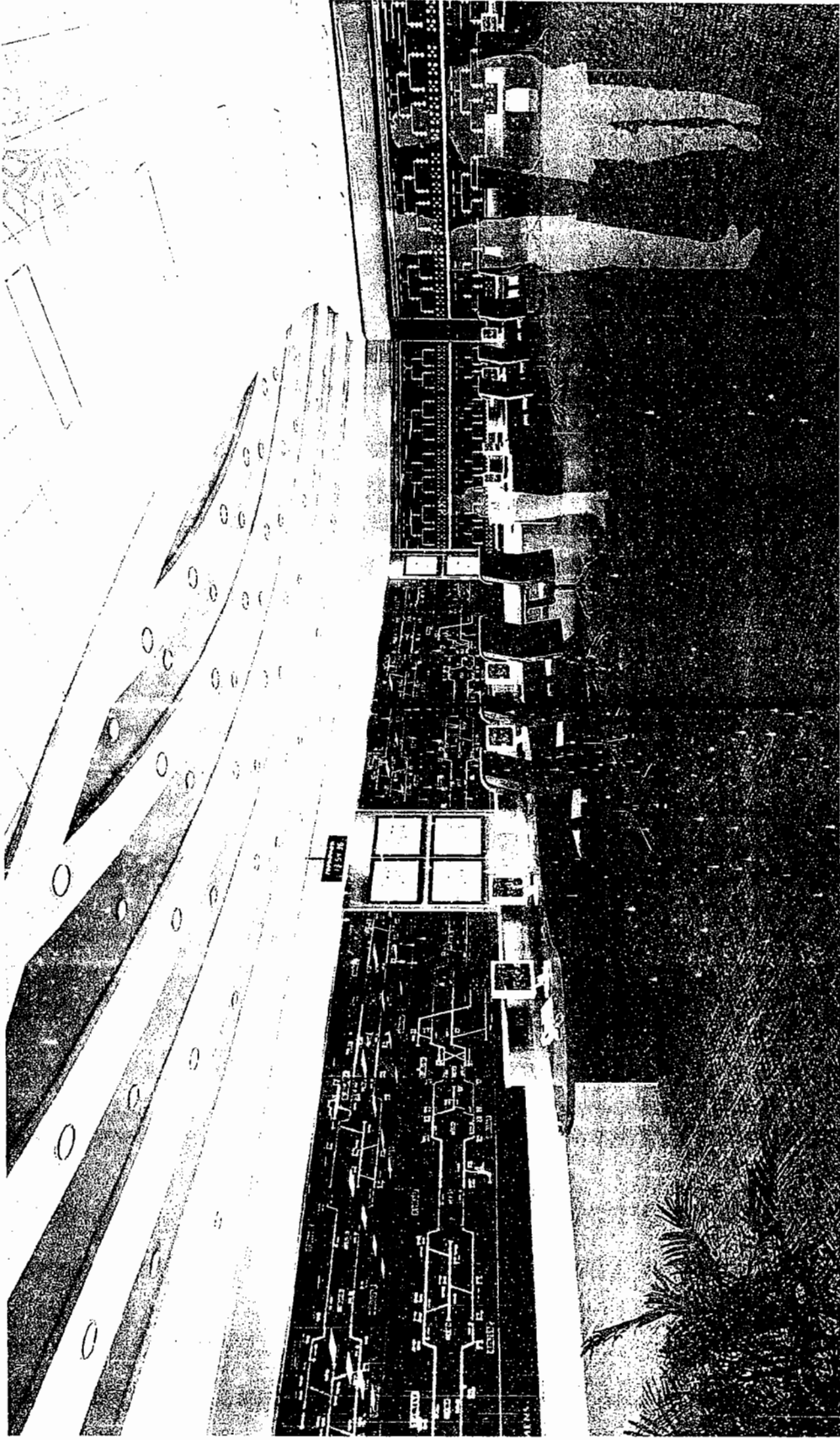
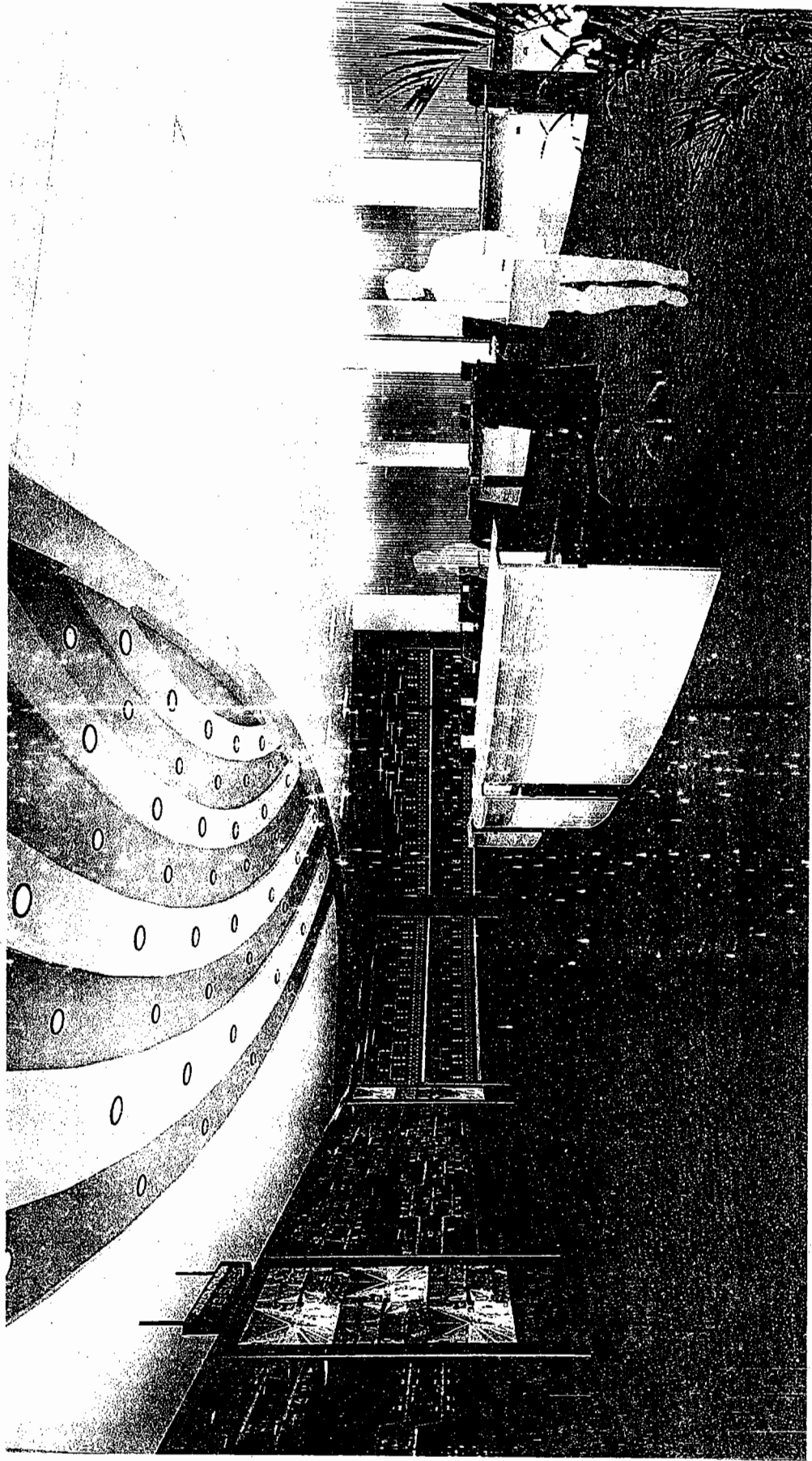

Fig. 17.3 - Computer Simulation of Typical OCC (3-D View 2)



CHAPTER – 18

COMMISSIONING, TEST RUN AND TRIAL RUN

18.1 Commissioning and Test Run

18.1.1 General

The testing and commissioning process is to demonstrate that the setting to work of a physically installation of a system is complete. This phase commences when the installation of the system has been certified as complete. The commissioning process will include and cover all tests and adjustments necessary to ensure that the particular system is safely set to work and, as such, demonstrate that the design criteria have been met.

The Test Run phase is to demonstrate that the railway meets its pre-defined operational requirements by performing a series of integrated system tests with the energisation of the overhead line to allow the integrated system commissioning to be carried out with the Rolling Stock

18.1.2 Civil Engineering and Trackwork

- Track alignment for the Corridor is on elevated structures from Versova to Ghatkopar including the spur line from Airport Road to Airport Station. All materials required for Civil Engineering works and tracks to be tested in person of the MMRDA Engineer or the MMRDA nominated consultant at the manufacturers' workshop as per the various codes and practices, before dispatching to site. All the test certificates will be properly documented for scrutiny by Safety Commissioner if required.
- After completion of the Way Structure in all respect, one or two spans are to be tested for design load capacity as per the IS Codes and specifications. A detail note will be prepared giving the specifications of the material used and all type of tests carried out during the construction and also copies of test results will be enclosed. The test results will be submitted to the Commissioner of Safety or made available for his inspection whenever required.

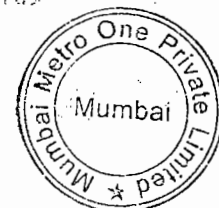

- After complete construction of all station buildings detail note to be prepared giving the specifications of the material used and all type of tests carried out during the construction and also copies of test results are to be enclosed. All the documents and drawings required for getting No Objection Certificate for opening of station buildings for public use by the Corporation will be submitted to the Commissioner of Safety through MMRDA.
- All the track material required for construction of Railway tracks are to be tested and inspected by MMRDA Engineer or MMRDA nominated consultant as per the Indian Railway codes and specification or to the International Specifications. After the receipt of all the materials the track work will be carried out as per the Indian Railway Codes and Specifications. After completion of track work the MMRDA Engineer or MMRDA nominated consultant will check all the parameters laid down in permanent way manual of Indian Railways characteristics adoptable to Standard Gauge to the extent applicable for Standard Gauge. Ultrasonic test along the complete length of track will be carried by the MMRDA Engineer or MMRDA nominated consultant to ensure there are no cracks in the rail and rail joints. The testing machine fitted in the Engine / Motor coach/ Tower Wagon will be run for the complete section. The testing machine reports are completely analyzed and the defects if any indicated by the machine are attended. All the checked parameters of track and track testing machine report and track testing machine compliance reports will be submitted to the Commissioner of Safety and MMRDA.

18.1.3 Traction Power Equipment and Auxiliary Power Equipment

- All the high voltage transformer as well as low voltage transformer, H.V. switchgear, isolators, circuit breakers and lightning arrestors will be tested as per IS/BS/International Standards at the manufacturer's premises as per standard proforma approved by MMRDA.
- Similarly all the L.T. switchgear, circuit breakers, lightning arresters will be tested as per IS/BSS Standards at the manufacturers premises on the standard proforma approved by MMRDA.
- H.T. and L.T. Equipment will be erected in the respective sub-station and commissioning test such as electrical insulation level, high voltage testing, and performance of safety relays will be carried out as per the standard proforma approved by MMRDA.
- All the records of individual equipments as well as combined test results of sub-station will be recorded and maintained.



- The sub-stations will be energized with incoming supply and kept on energizing for 24 hours to observe the behavior of all equipment.
- After successful observation, the sub-stations are deemed as commissioned.

18.1.4 Over Head Equipment (OHE)

- All OHE Equipment such as OHE masts, contact wire, catenary, OHE fittings and insulators will be tested as per relevant IS / BS / IRS specifications at the manufacturers premises with relevant test sheets prepared and approved by MMRDA will be carried out.
- After successful tests the Equipments will be accepted and cleared for erection.
- After erecting the equipment test will be carried out for electrical insulation strength will respect to earth by insulation tester.
- High Pressure testing of the erected equipment will be carried out.
- Static tests to check the conductor tension, electrical and mechanical clearance, setting of tension weights and pulleys, height and stagger checks at supports and at mid-span will be carried out.
- Low speed running test to check the contact wires will be carried out
- All the test reports of individual equipment as well as combined system test results will be recorded and maintained.
- The system will be energized at 25 KV A.C. and short circuit test will be carried out to prove correct operation of protection equipment and loading requirements of overhead equipment are met.

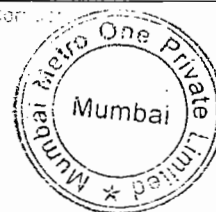

18.1.5 Station Lighting/Air-conditioning/Lifts/Escalators

- Equipment will be erected at their appropriate places and tested for their performance.
- Inspection of safety equipments, lifts, escalators, and air-conditioning equipments will be carried out by the respective inspectors and approved as required.
- During testing, all the safety aspects will be ensured as then only equipment will be deemed to have commissioned for public service.
- All the test results and approvals will be properly recorded and maintained.

18.1.6 Signaling & Communication Systems

18.1.6.1 General

- All Signal and Communication equipments will be subjected to inspection and test before and after installations to ensure proper functioning and there are no infringements of schedule of dimensions.
- Test will be as per the test formats specified by equipment manufacturer for all vital equipments and a program will be prepared for their tests.
- Proper calibrated test instruments and equipments specified by equipment manufacturer will be used for all safety equipments.
- Inspection and test will be carried out by authorized personnel and test certificates of all vital equipments will be obtained and records maintained.
- It will be ensured that qualified and competent operating staff are recruited and trained so that adequate operating and maintenance staff are posted at strategic locations and arrangement for handling emergencies are made available and Safety Commissioners' sanction obtained before commissioning the metro system for public conveyance.

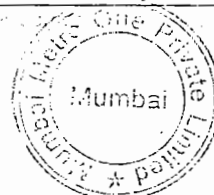

- Before Test Runs, it will be ensured that all maintenance facilities, diagnostic and monitoring equipments are in place, S & T maintenance and safety manuals are finalized, rules, regulations and procedures are laid down for train operation and maintenance of all equipments.
- A through test will be carried out from OCC, integrating all the systems and will be kept ready for commissioning.

18.1.6.2 Signaling Equipment

- Track side equipments such as Point Machines, Signals, and Track Detection Devices will be individually tested during the installation stage and also after the installation.
- All Point Machines will undergo obstruction test and correspondence test with position of points.
- Aspect control test will be carried out on all line-side signals.

• All circuits will undergo test as specified by the manufacturer and adjusted for proper train current resistance.

• Track side train detectors devices like Beacons and Cable loops will be tested for their correct functioning.

- Interlocking and interfaces at all way side stations and Car Depot will be tested thoroughly simulating failure conditions to ensure no unsafe condition exist in the interlocking.
- All signaling cables will undergo insulation test before and after laying Fibre Optic Cable for its parameters to check any deterioration during laying and record maintained.
- Train-borne ATC equipments will be tested as per test procedure on test track and kept ready for trial with close co-ordinations of Electrical Engineers.

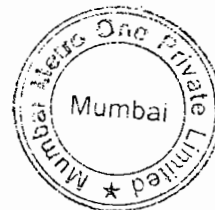

18.1.6.3 Communication Equipment

- Optical, Modulation as well as multiplexing subsystems of OFC network system will be tested for integrated functioning of all Signal & Communication equipments to ensure correct functioning.
- Individual systems such as Electronic Exchanges, Trains Radios, PIDS, CCTV System, Clocks, PA system and AFC systems will be tested for meeting delay and error-rate etc. requirements locally and kept ready.
- All OCC equipments including Mimic panel, Controller's Consoles will be tested locally and after completing all interfaces with other sub-system, the whole integrated system will be tested for correct functioning.

18.1.7 Rolling Stocks (E.M.U.)

- On receipt of EMU coaches from the manufacturers at the car shed will be lifted and placed in the inspection bay of the Car Depot.
- All the electrical test and mechanical tests of equipment will be carried out and to ensure that they conform to Standard Specifications.
- Motor coaches will be energized and commissioning of equipments, safety relays and control equipment will be tested as per standard proforma.
- After proper functioning of equipment the motor coach is taken for test run on the test track in the Car Depot.
- After successful performance of motor coach formation of the prototype rake will be made and test runs taken in the Car Depot on the test track.
- After successful performance test runs will be carried out on the main line.
- Prototype Vehicle will be used in empty as well as loaded conditions during test runs.



- Load of passengers will be simulated by loading the coaches with appropriate concrete blocks as required.
- Test run will be carried out with all Electrical/ Mechanical equipment functioning normally.
- Test run will be carried out by cutting out one and two traction motors.
- Test run will be carried out by coupling another dead coach to access the capacity of towing.
- Test runs will be carried out for maximum designed speed in steps of 10kmph from 40kmph as required.
- Starting and running adhesion test and brake test will be carried out as required.
- Ability to start on steepest gradient at minimum voltage with adequate acceleration reserve will also be tested as required.
- Ambient noise measurement i.e. measuring of harmonics and sophomoric currents in traction return circuits will be carried out and recorded.

18.1.8 Integrated System Testing

18.1.8.1 System integration tests will be carried out in Test Run to demonstrate the interfacing/functional requirements specified for the traction power equipment, OHL equipment, communication system, signaling system and the rolling stocks are met.

18.1.8.2 The system integrated test will cover the following tests :

- Electromagnetic Compatibility Test
- Radio Coverage Test
- Signalling Invariance/Trackside Dynamic Test
- Signalling System Dynamic Test



- Radio/Train Identification Test
- High Speed Test
- Headway Test
- Traction Power Performance Test
- Other Platform Equipment Integration Test

18.2 Trial Run

18.2.1 General

18.2.1.1 Trial Running is required to demonstrate the following:

- The elements of the MRTS, necessary for the proper implementation of service to the public can be operated in a successful and stable way,
- The staff training of Operational Personnel is sufficient for opening to the public,
- The instructions in the Operations Procedures are practicable, logical and correct; and
- The Maintenance Organisation is sufficiently set up for opening to the public.

18.2.1.2 The Trial Run will consist of Timetable Running, Degraded Operation and Emergency Operation Exercises and will include the following as specified:

- The operation of a full complement of trains as required for scheduled service, including periods of peak demand and periods of maintenance:
- The determination of the actual headway achieved at each station for all specified routes, including intermediate reversing movements and movements into and out of the depot.



- The intentional disruption of the service including simulated extended dwell times, vehicle failure, power systems outage, point failure and train detection failures and, if applicable, ATP and ATO failure, point failure and train detection failures in order to check operational stability, the safety of the system and the effectiveness of procedures and of the ATR system.

18.2.1.3 After successful clearance from extended trial runs, application will be made to the Safety Commissioner giving all relevant test reports for his inspections and approval as required.

18.2.1.4 After Approval from the Safety Commissioner, MRTS will be ready for regular passenger service.

18.2.2 Timetable Running

18.2.2.1 Timetable running means performance of daily operation according to different timetables, without passengers. Timetable running will demonstrate and verify that the Railway Organisation and Staff are sufficiently trained in order to gradually reach the required operational standard for normal operation. At the same time, timetables and other operational and maintenance plans will be proved and verified. The headway will gradually be reduced in order to reach at the end the required headway of commercial operation.

18.2.3 Degraded Operation Exercises

18.2.3.1 Degraded Operation scenarios include:

- Blocked lines or line sections
- Short-loop train operation
- Train shuttle operation
- Loss of signalling connections to the OCC.
- Failure of ATP/ATO, point, track circuit
- Moving of stalled trains
- Failure of train passenger doors
- Platform stopping point missed by train
- Extended dwell time
- Loss of traction power supply
- Loss of station power supply
- Response to station equipment failures (escalators, lifts, AFC and gates).



18.2.3.2 The following will be demonstrated by Degraded Operation Exercises:

- Demonstration and verification of sufficiently trained Railway Organisation, including Rules and Regulations
- Acceptable reaction of staff in case of failure or long-lasting maintenance of parts of system or equipment
- Familiarisation of staff with use of system and equipment which has reduced performance
- Demonstration and verification of sufficiently trained Maintenance Organisation and staff.

18.2.4 Emergency Operation Exercises

18.2.4.1 Emergency Operation scenarios include:

- Total loss of infeed power
- Emergencies affecting passengers on board trains
- Stalled train and de-railed train
- Fire on trackside or in station
- Station evacuation.

18.2.4.2 The following will be demonstrated by the Emergency Operation Exercises:

- Demonstration and verification of sufficiently trained Railway Organisation, including Rules and Regulations, especially for accidents and incidents
- Demonstration and verification of successful co-operation with third (external) parties, such as police, security, fire fighting and rescue forces
- Testing of correct and fast reaction of staff for cases of real life emergencies
- Familiarisation of staff with use of emergency equipment.



CHAPTER – 19

OPERATION AND MAINTENANCE

19.1 OPERATIONS PHILOSOPHY

The fundamental elements of Operations consist of the safe, convenient, fast, reliable and punctual operations of the Mass Rapid Transit System (MRTS) design coupled with the well trained personnel and practical operational procedures in the MRTS Project should be able to help achieving these critical operational elements and requirements.

19.1.1 Vision & Mission

In line with the company goals, the Operations Department will have its own vision & mission to guide all activities of forward planning.

19.1.2 Presentation of the operator and maintenance Company, Connex: Transport as part of life

19.1.3 Objectives

The objectives of the Operations shall be defined as :

To provide a safe, comfortable, convenient and innovative Rail based Mass Rapid Transit System to the community.

To meet the general public's travelling demand by following the government's public transport policy and proactively coordinating with all other existing transport operators to form an integrated public transport network.

To provide a cost-effective public transport means by working continuously on enhancing operational efficiency and reducing operational cost.

To recruit suitable personnel to fill the required posts and provide sufficient training for attaining required qualification.



To develop practical rules and procedures that should be constantly reviewed for improvement.

19.1.4 Security, Safety & Quality

Safety is a pre-requisite for everything we do.

Be aware of potential hazards and promptly mitigate them before accidents arise.

Do the right things, right at the first time and every time, whilst maintaining the integrity of the railway system.

A Safety Management System will be developed for ensuring the safety of the MRTS.

International Standard, such as ISO 9000, will be adopted for the Quality Control of the system.

A Passenger Security and Information System will be developed to ensure the system and the passengers are properly safeguarded.

Continuous Improvement

Continuously strive to achieve better service performance and at lower cost.

Cost-effective

Optimise the use of resources and efforts to maximise value and return on investment.

Find more innovative ways to do more with less.

Prioritise investment items on the vital few.

Be aware of the real cost of operations and maintenance.

Operational Policies

The following policy statements provide guidance on the safe, convenient, fast, reliable and punctual operations of the MTRS by the Operations Division:

- Safety Policy
- Quality Policy



- Environmental Policy

These policy statements shall be clearly communicated to all levels of staff and unambiguously understood and adopted by them with the full commitment and support from top management.

19.1.5 Regularity

The performance and reputation of the MRTS are linked together. The delivery of a highly reliable service day-in-day-out takes dedication. However, hard work alone will not achieve this. Clear standards for performance, focused and well-trained staff supported by effective equipment are essential in maintaining a high level of reliable train service. System performance will be constantly monitored and enhanced through the continuous improvement cycle.

One of the major critical factors affecting the train service performance is maintaining a regular headway between trains. The constancy of the headway enables regular transportation of passengers during peak hours. Any unexpected minor delay of a train may have the possibility of becoming a major service disruption.

Regularity can be achieved through the implementation of the following measures:

- Centralization of train service information so as to react as quickly as possible to disturbances and unavoidable incidents,
- Availability of rolling stock, track layout (e.g. emergency siding) and equipment design which in turn enhance the system reliability and operability.

19.1.6 Convenience and Comfort

To achieve convenience and comfort throughout the passengers' journeys require careful and delicate planning. The MRTS will strive to identify and pursue continuous improvement in customer services in terms of user-friendliness and added-value services. Periodic customer surveys will be used to assess performance and areas where improvements should be made.

There are many different factors contribute to passengers' convenience and comfort. Prior to boarding trains, passengers should have easy access (such as lifts, passenger



information display boards,) to any information they may need. The station signage and publications (e.g. leaflets, route maps etc) will provide a simple and clear information of available routes, identify stations or stopping points, suitable exit directory and explain where and how to transfer to other transportation modes. The general public will be easy to get the relevant information regarding fare collection.

Comfort consists of:

The perception offered to passengers in station, whose particular features, layouts, colours and even background music as a whole must be harmonious and coherent;

Movement and information facilities, characterized by simple and efficient indication of one way direction whenever this is possible, and the use of escalators and visual, audio and audio-visual information facilities;

The general characteristics of the rolling stock: the cars must be well designed, well lit, well suspended, noise-free, well ventilated and equipped with a public announcement system;

Integration and co-ordination with other public transport modes,

Adaptation of service according to the traffic density.

19.1.7 Fast and Punctual

Rapidity is a necessity of modern life; the mean distance between the work place and the home is continuously increasing in large developed cities. A reduction in travel time must be sought for, not only at train movement level, but also as far as access to trains is concerned by an adequate layout of stations throughout the urban area, and by obtaining a sufficiently short and regular headway between trains.



19.2 Mobilisation plan

A start-up period (the mobilisation plan) is necessary for follow-up of design and construction of system, and preparation of operation, occur between effective Date and reception of Operating Certificate according to the milestones of the RFP documents.

19.2.1 Introduction

Connex has considerable experience in managing the preparation phase before the operation of a new transport system.

This experience has been gained via the following projects:

- The Nancy trolleybus network which came into operation in 1985 on a network of 40km of lines with 48 articulated trolleybus vehicles, each 18m long.
- The Rouen LRT metrobus network, brought into operation in December 1994 on a network of 12km of tramway lines, increased to 15.2km with 28 Alstom vehicles, of the Grenoble type
- The Lisbon Fertagus commuter rail system which came into operation in July 1999 on a 22km network with 8 stations and 18 double-deck 4-car trains from Alstom and CAF
- The Rouen TEOR guided bus network brought into operation in January 2001 with a first stage of 12km with 38 AGORA type vehicles. The diesel-powered buses with optical guiding system will be replaced progressively by 58 CIVIS vehicles from mid-2002 and the network will be increased to 38km of lines
- The Nancy TVR network commenced in January 2001. This network runs vehicles guided by means of a ground-based axial rail covers a first stage of 11km with 25 TVR Bombardier vehicles, 24m long
- The Bogota Transmilenio network (Colombia) brought into operation in January 2001. The network covers 40km of bus lines (two lanes, 78 metro type stations with 1, 2 or 3 platforms and TVM equipment) and is equipped with 330 articulated buses,



18m long (brought into operation in August 2001). The network has a daily traffic of 550 000 passengers. 140 additional buses are to be provided in the coming months to ensure an interval of 20 seconds. Connex runs 100 buses of this network in partnership with local companies

- Bordeaux LRT. The 25km long network will have six Citadis 302 train sets and 38 Citadis 402 train sets
- Barcelona LRT tramway. The 15.2km long network has 20 Citadis 302 train sets.
- Dublin LRT.

19.2.2 Management, staffing, industrial relations, training and administration

Connex will set up an organisation able to successfully handle the somewhat complex network of relations. This requires in particular a high quality and efficient information system and documentation management.

The organisation chart below represents the information flows during the pre-operation phase (Connex global team only):

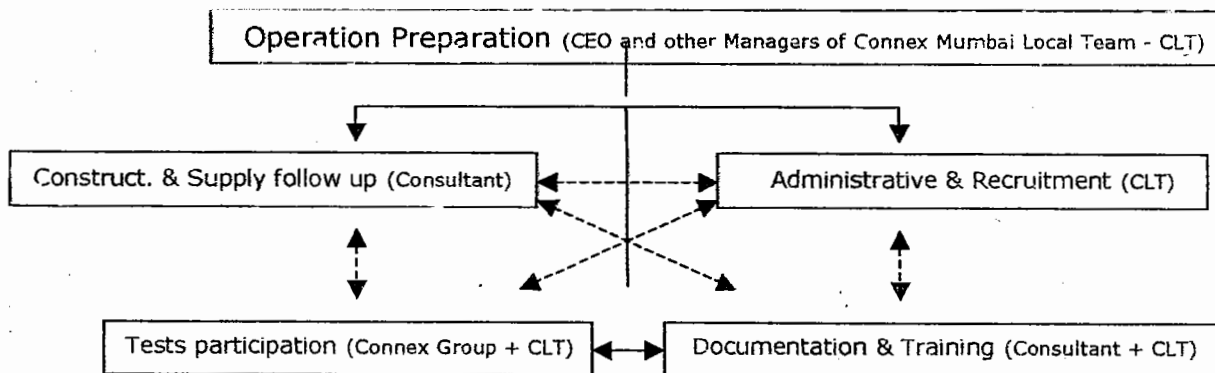

In order to make this organisation very efficient, we propose to use the assistance of an international consulting company being a specialist of multiple participants in transportation projects. Contacts have already been made with such companies for a later selection process.

In addition, Connex proposes to improve the process by using the assistance of other companies operating light trains, Metro and/or rail operation in the Connex Group. The assistance from France, Sweden, Spain and the UK will be called upon at short notice for tasks requiring in-depth experience that is not easy to build up in a short timescale in the first stage of pre-operation. Some important tasks such as the safety case may also benefit from addressing the experiences in different cities and countries in Europe as national safety practices differ.

19.2.3 Document processing

Connex through the SPV will establish and maintain procedures for controlling all documents required to ensure that:

- They can be located;
- They are periodically reviewed, revised as necessary and approved for adequacy by authorised personnel;
- The current versions of relevant documents are available at all locations where operations essential to the effective functioning of the operations are performed;
- Obsolete documents are promptly removed from all points of issue and points of use, or otherwise assured against unintended use;
- Any obsolete documents retained for legal and/or knowledge preservation purposes are suitably identified.

Documentation will be legible, dated (with dates of revision) and readily identifiable, maintained in an orderly manner and retained for a specified period. Procedures and responsibilities will be established and maintained concerning the creation and modification of various types of document.

The primary focus will be on the effective and safe operation of the system, not an overly complex documentation control system.



19.2.4 Organisation and staffing of the Company

The Proposed organisation of the Operating Company is as follows:

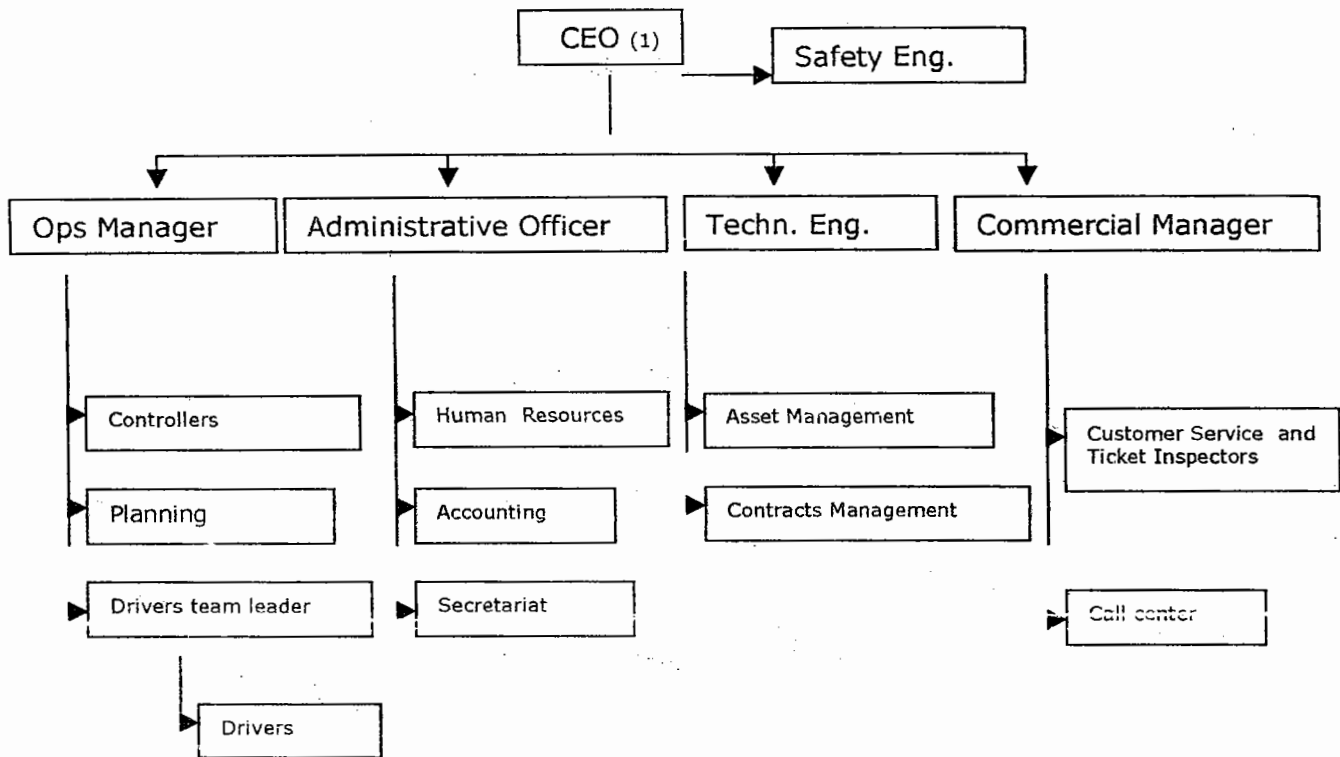

This organisation could assume if necessary a certain level of sub-contracting, like the maintenance.

The Safety Engineer is directly reporting to the CEO in order to guarantee the maximum freedom and objectivity in this particularly sensitive question. His duty is mainly safety (safety case, incident reports organisation, incidents analysis, validation of procedures).



He will also be involved in training as training and qualification are key factors of a safe operation.

The inspectors (and customer service personnel –controllers-) are attached to the marketing department as they are one of the most important teams in terms of building up the Company's image and customer relationships as well as one of the main factors to avoid fare evasion and increase ridership revenue.

The number of staff in the technical part is reduced due to the delegated duty in the field of maintenance. However, we propose a staff of three to perform the specific tasks not taken care of by the maintenance companies, e.g. asset management, and so as to ensure a smooth and efficient relationship between operation and maintenance, which is important to achieve the best quality service.

19.2.5 Industrial relations

In the mobilisation phase Connex would establish the key elements of its Human Resource policy laying out the intended structure for Recruitment, Remuneration Retention and Discipline of staff. Policy would also be established to ensure that within the company discrimination and harassment would not be tolerated.

These policies would be based on existing Connex policies in use in other countries which will be adapted to the law and local conditions in Mumbai.

We would establish from the outset an internal communications plan which would enable the company to have a regular two way communication with its growing workforce. This would be in the form of regular face to face team briefing sessions augmented by a form of staff newsletter which would encourage comments and suggestions from the employees.

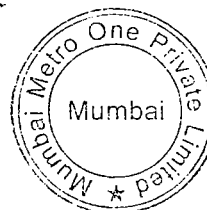

19.2.6 Training

Training is one of the main parts of the mobilisation plan. It requires rigor in preparing the documents as well as flexibility to adjust them to whatever decisions regarding modification may be taken during the preparation phase. It requires also a permanent follow up with the Suppliers and Constructors who have to supply the descriptive documents in due time.

Training concerns everyone in the company. Connex commits to deliver the relevant training to the staff to obtain all the necessary certificates.

Of course, the main population is drivers. We attach as Appendix the content of the training which was set up for the mobilisation phase of the Rouen's LRT (locally called "Métro"). It shows the detail of the training when made by Connex. The training for Mumbai will have a similar scope.

A normal duration for driver training would be 6 to 8 weeks depending on individual background and organised in teams of 15 to 20 with classes starting every 4 weeks.

The commercial and operating supervisors as well as the traffic inspectors will be trained to manage all or part of:

- Train control
- Signalling systems
- Ticketing systems
- Station equipment

First, they will be shown the operation of these systems during the driver training. The additional training will be ensured contractually by the various suppliers. This training will deal with the use of the equipment and their technical specifications. All training courses will be organised and supervised by the Operating Manager and the Safety and Training Manager.

As training is an ongoing process and concern of the company, we make reference to the Operating Plan where we describe it as a part of a permanent training organisation.



19.2.7 Safety planning

As safety actually involves all other activities within the company, we describe here the safety planning action before the Operations and Maintenance planning actions.

Connex Mumbai will have developed the basic documentation and procedures required:

- Rule book for the Driver : states the requirements for the routes worked and the rolling stock used on those routes in normal and degraded situations
- Route books with information about the running of rolling stock in normal and degraded situations
- Qualifications of staff with safety-related duties
- Personnel selection, initial vocational training, initial certification, maintenance of qualification level and follow-up, maintenance of certification referred by the Irish regulators.

Safety planning will be worked out by 5 persons:

- The Safety Engineer (team leader)
- The Operation Manager
- The Technical Engineer
- 2 Technicians

This team will draw up the operating procedure of the Mumbai Metro line jointly with the various equipment suppliers in order to comply with their specific safety regulations.

According to the specification, Connex Mumbai will establish a safety and emergency planning forum by working closely with the Client and the relevant authorities (fire brigade, police, road traffic authority, power suppliers etc). The backbone of the future safety case will be worked out with the MMRDA top down from the Effective Date.



19.2.8 Operations planning and testing

The preparation for operations requires that a team be dedicated to (a) analysing the system and system components, (b) producing documents and procedures including the rule book and (c) preparing the organisation of the future operation (including timetables and staff organisation).

Analysing the system and system components requires a sound knowledge of Light Trains and Metro operations. This task will be carried out by a team led by the Operations Manager and including experts from the Connex Group as well as our consultant.

Production of documents and procedures will be the responsibility of the staff of Connex Mumbai. Early drafts may be prepared by Connex experts and consultants but the final documents are to be validated as the result of an iterative process.

Preparation of the organisation will be carried out using the various Connex software/systems.

Detailed operations planning will be worked out by two operating technicians who will be trained specifically to the following management and design data processing equipment :

- STANZ for drawing the routes and time schedules
- GBM for preparing the routes and services of drivers and vehicles
- FDS for assigning drivers and for their monitoring

All these Connex tools are designed with a shared Access database which enables any exchange of data and files between the various systems. These systems can be easily used with Windows software.

We have assumed that data exchange with the various contractors will be possible and easily achieved.



The analysis and processing of the operating electronic management system will provide all the necessary data to have accurate knowledge of running times during the day and the week. This data will be used :

- As a benchmark for the future operation
- As an optimisation tool for timetabling
- As a tool for negotiation with the road traffic authority for prioritisation at traffic signals

Finally, the operations testing will be carried out during the trial running phase before operation with passengers.

Connex will need to have access to the whole of the transport system in order to test it and run it before launching the commercial operation.

During these two periods, Connex will be responsible for managing the section of the network under their responsibility and will cover the energy costs.

The various maintenance works will be carried out by the designated contractors. Connex will be responsible for co-ordinating and monitoring the tasks in accordance with their maintenance planning.

The network operation will be tested without passengers in accordance with the current operations plan and the number of train sets running in commercial operation for around 2 months. This procedure requires that every train of the set runs between 5000 and 10 000 km with a view to detecting any faults and providing safe systems and equipment.

The testing procedure will be broken down into 3 phases :

- Running for driver training
- Certification of the off- and on-board network equipment. This phase is intended to establish the optimum speed in commercial operation
- Running according to the timetable for approximately 1 month in order to check that all systems and equipment are fit and de-bugged. This phase makes it possible for the network staff to become accustomed to this new transport system before launching the commercial operation.



19.2.9 Maintenance planning

As part of the draft testing and trial running plan, Connex will define the maintenance planning.

In the first month after the Effective Date, Connex will produce the draft preliminary System Maintenance Plan. This preliminary plan will take into account the maintenance plan provided by the suppliers for each sub-system.

19.2.10 Testing Periods

During the vehicle and equipment running-in test period, the maintenance, tuning and retrofitting operations will be carried out by the suppliers at their own expense.

Connex will be responsible for providing drivers for these tests (in reasonable numbers, say, 4 per day).

19.2.11 Testing Performance Meetings (TPM) – a system for follow up testing and start up

Connex plan to set up special weekly Operations Performance Meetings (OPM) for the purpose of follow up each week of passenger operation within the Mumbai Metro network. As a "prelude" to these Operations Performance Meetings Connex will set up weekly Testing Performance Meetings (TPM) after the same model used in Stockholm during the testing and start up phase of the new Stockholm LRT. The TPM is also a "preparation" for the coming Operations Performance meetings (OPM) coming after commencement of each line.

Connex operations- maintenance- commercial and safety departments will take place in the Testing Performance Meetings together with the Ticket Machine Contractor.

As the OPM first of all will be focusing on operations reliability, punctuality and other customer service as well as safety, the TPM in the beginning will be rather "technical". As the time schedule runs closer and closer to commencement of each line the TPM will be more and more like the OPM:s During a period when line A/C is already opened for



passengers and the line B is still under testing, the two types of meetings will run parallel but will normally not been mixed.

Daily reports (computerised logs) from the control room are used as a basis for the discussions on TPM:s as well as OPM:s. The staff at the control centre compiles these for both type of meetings.

19.2.12 Driver Training

During the testing period, a part of the rolling stock will be at the disposal of the operator as well as part of a finished section of the line connected to the depot, together with a sufficient stabling area.

19.2.13 Customer services and interface planning

The Commercial Department will be comprised of a Manager, multi-functional inspectors and call-centre operators.

The Commercial Manager and his team will take part in commissioning the ticketing equipment and prepare the training of the remaining staff.

The team will prepare data to be displayed on-board and at every stop (timetables, maps, customer service rules etc).

The team will take part in the advertising campaign for the Mumbai Metro network with the advertising company to be selected by the Client (topics to be covered, programme, timescales etc).

The team will prepare the management of all statistical data (customers, fraud, claims, customer relations).

The team will organise the management of ticket income, ticket stocks and ticket machines in stations.



19.2.14 Third party matters

The main interfaces of this new transport system to be managed and organised will be :

- Platforms
- Overhead power supply
- Relations with the police and fire brigade
- Relations with the other transport operators in Mumbai in order to co-ordinate timetables and to manage commuting operations

All these tasks will be managed by the executive of the local company, who will be assisted by :

- The Technical Engineer and the assets manager
- Technicians from the Operations Department
- The Safety Engineer
- Traffic controllers

Minutes of meetings on the above topics will be made available to the Client for information.

19.3 OPERATING PLAN

19.3.1 Operation Features

Operating specifications are the key component of any railway system. They are inherently linked to the geometric characteristics of its routes and to station design parameters. They will be compatible with the physical configuration of the transportation system in order to achieve commercial speed, service regularity, and carrying capacity objectives.

The key objectives of the Mumbai Metro project, to be delivered by means of the Operating Concession include:



19.3.2 Modal Shift

The modal shift is the result of a great number of varying factors, some of them are dependant on the operator. Among the various factors, one may find structural factors such as the geographical position of the line as well as the number of stops and their location in relation to houses and employment places. Those factors, once decided may not be changed until new extensions of the Metro lines are decided. Structural factors are obviously fundamental to assess the attraction of Public transport. Next are the reinforcing factors such as the general traffic in the city or the interconnection with other transportation modes (buses, trains). Those factors may be changed with some efforts requiring political support. Reinforcing factors may have a huge influence on modal shift. Lastly come the complementary factors such as quality of service and communication. Complementary factors can (and have to) be easily tuned to react quickly to events. They have a real influence on the final choice towards public transport. Concerning reinforcing factors, Connex understands it will be fully part of the discussions and negotiations with local authorities, be it during the pre-operation phase or during the operation period, to present and defend the position of public transport versus private cars in the permanent adjustment of the city of Mumbai to cope with a balance displacement scheme in its general development process. Lastly, concerning complementary factors, the Connex will set in place the quality of service (targets, follow up, corrections, improvements) it developed in its other operations (punctuality, cleanliness, information, reactivity) and Connex will actively participate in analyses and proposals concerning fares, which must not be forgotten as another complementary factor.

19.3.3. Integration of Transport

The System should be operated to complement both inter-modal and intra-modal integration.

Connex is fully aware of the revolution that the Mumbai bus service utility will have to face in the coming years with the full implementation of the Public Transport general plan which is now underway (Metro, trains). It would be too simple to think that these changes will all be beneficial to the bus utility and to the drivers, Connex experience in participating in light trains and/or metros in cities where buses had the whole share beforehand makes us very much aware of the huge changes to carefully analyse, prepare and negotiate.



Connex will start discussing with bus companies as soon as possible to gain their co-operation in a positive way. Connex experience shows that when well prepared, with understanding positions of both sides (MRTS and buses), the opening of the metro is a success.

Inter-modal actions (mainly public transport + private cars) mainly cover Park and Ride sites which should be well prepared and taken into account. Even though having a reduced number of car parks under contract than Parking Companies fully dedicated to parking management, Connex still has some experience of those Park and Ride sites which require specific solutions and actions as Park and Ride car parks are not managed exactly like other car parks in city centers. Connex is well aware of the importance of Park and Ride sites in the patronage of Metro as well as in the global image of public transport.

19.3.4 Accessibility

The operation of the System should fully support the use of the Metro by all people.

Management of disabled passengers will be a part of personnel training (drivers and controllers in particular). Safety actions will take disabled passengers into account.

19.3.5 Enhancing Efficiency, Innovation and Customer Focus

The System should be operated to focus on customer service and on managing the Mumbai Metro within a sound business framework.

The contractual relationship initiated by Mumbai Metro for the operation and maintenance of the Metro is the basis for the sound business framework. The whole system shall be placed under the philosophy of PPP. This is a difficult process, not easy to achieve, of a relational system between private companies, usually uniquely focused towards financial results and public authorities, usually not taking into account the private risks. Actually, Connex emphasizes that, notwithstanding the normal background of being a private company, within a private group VEOLIA Environnement, Connex business is recognized as being very dependent on a sensible long term relationship with the public authorities and the passengers. Unlike some other operators in the transportation world, Connex avoids being a simple financial partner without full operational and managerial responsibilities and Connex avoids voluntarily pulling out of any place with full acceptance



of one of the basic rules of PPP which is the call for Tenders and open avenues to competition.

19.3.6 Safety

The Operating Concession should incorporate the principle that risk to safety and health should be as low as reasonably practicable.

Safety is a complicated field which Connex fully knows and acknowledges. Connex, having the experience of light trains, metros and of rail operations, masters the combination of high safety and smooth operations. This mastering requires a very precise definition of the procedures (normal and degraded operations) as well as a precise follow up process and adaptation methodology (reviewing incidents, analyses of new situations, creation of or changes in procedures, approval processes). In this respect, the position of safety engineer is directly attached to the CEO of the Company, in an equivalent position to the operations director and to the administrative director, with a relational link with other safety engineers of light trains, metros and rail in the group and in the profession (e.g. UITP Brussels).

19.3.7 System assumptions

Description of system to be operated and maintained

The system to be operated and maintained shall meet the specifications and requirements of the tender documents, in particular the Concession Agreement and the Project Requirements, in particular:

- The train service will operate on a main line between Versova Station in the West and Ghatkopar Station in the East.
- A bifurcated service will be operated from Airport Road to Sahar Airport in the South.
- There shall be 13 stations (12 stations on the main line + 1 station at the airport).
- Metro vehicles movements shall be monitored and dispatched from an Operating Control Centre.



Scope of work

Connex (the "Operator") is responsible for operation and maintenance of the system for the whole duration of the concession under an operation and maintenance contract with Mumbai Metro One (the "Concessionaire"). Connex could sub-contract maintenance to another company (the "Maintenance Contractor") under a separate maintenance contract. These contracts have been defined in detail the scope of work and interfaces.

The Operator is responsible for:

- daily operation of the system
- interface with the Maintenance Contractor and supervision for all maintenance issues
- cleaning inspections of Metro vehicles during the day
- removal of grafitis and other damages caused by vandalism
- Management of advertising in the system will be carried out by the Concessionaire

The Maintenance Contractor is responsible for:

- daily maintenance of the whole system, including cleaning, preventive and corrective maintenance
- scope of work includes rolling stock, infrastructure and all rolling stock equipment and components
- capital asset replacement of all components of the Metro system

The Operator has a System Director reporting to Managing Director in charge of interface and supervision of maintenance with the Maintenance Contractor. The Maintenance Director of the Maintenance Contractor will report to the System Director and Managing Director of the Operator. Administration, operation and maintenance will be located at the same site, at the Versova Car Depot (or in alternative at Ghatkopar Car Depot), facilitating co-ordination.



Description of first year service plan

Operation of MRTS is planned on a double line elevated rail corridor along Versova-Andheri-Ghatkopar Corridor including a spur to International Airport at Sahar with Metro vehicles of 4 units each, during the whole day. During commercial operation, all Metro vehicles stop at all stations.

- Line length : 12.853 kms including the spur to Sahar Airport.
- Number of stations : 13.
- Commercial speed : 33 kmph
- Cycle time : 21 minutes between Versova and Ghatkopar including halt/dwell time.
- Total Metro fleet is 13 vehicles of 4 units each, including 11 for operation, 1 for operation reserve and 1 for maintenance reserve, during the first years of operation.

19.3.8 Estimations of Passenger Flows

Ridership estimate of peak hour and daily ridership and maximum one way peak hour passenger flow (PHPD) for the year 2011 (proposed year of opening of MRTS) and three more horizon years viz. 2021 and 2031 are given below:

Year	Hourly Ridership	Daily Ridership	PHPD
2011	41067	513338	18580
2021	53176	664703	23321
2031	70603	882533	30491

* Source Bid Document Vol. 1 Page 34



The minimum passenger carrying capacity of the system during different horizons years shall be as below:

Year	Passengers per hour per direction
2011	18600
2021	23600
2031	30500
2041	39500

*Source from Bid document Vol. II Page 3

The design train capacity considered for the sizing shall be 18600 pphpd along the line with a minimum 11 trains (4 minutes headway during peak hours) at 2011.

19.3.9 Service Standards

Connex has as the overall objectives in its public transport operating activities throughout the world the following three priorities in the order stated:

- High level of transport safety
- High level of reliability
- High level of punctuality

19.3.10 Transport safety

A high level of transport safety implies a high level of safety for metro passengers and our own staff. A high level of safety is a basic prerequisite for operating public transport services in the first place, for being able to attract customers while also constituting a legitimate, competitive alternative to other modes of transport. If a good level of safety cannot be guaranteed to the customer and the client, one of the most important building blocks for the popularity and success of the new metro system in Mumbai will fall away.



Connex has tried-and-tested systems for the safe operation of a metro service. Safety principles for all rail traffic (underground, railway and trainway) are to a large extent ubiquitous.

Connex has extensive experience of operating metro, trains and light trains services in France, Sweden, Spain, Germany, India, Australia, New Zealand, Czech Republic and USA, with the special requirements that this type of service demands with regard to safety.

In order to be able to provide a rail service with a high level of safety disregarding purely technical considerations there is a requirement for careful recruitment and training work. Connex has well-established procedures for the recruitment and training of its staff and keeping their knowledge up to date. Reference should also be made to section "System Organisation and Staffing" below.

19.3.11 Reliability

Connex has extensive experience of taking care of and ensuring a high level of reliability of transport services. In order to ensure staffing with the right number of drivers and other personnel, there are computerised systems for calculating requirements for human resources in the short and long term. When it comes to monitoring the status of the vehicle fleet and ensuring that vehicle maintenance subcontractors carry out the prescribed maintenance and make vehicles available that are fit to drive, safe and presentable, special log systems are provided. In the case of our operations in Stockholm (Metro, railway and trainway), all vehicle maintenance has been outsourced to a subcontractor. Within Connex, an organisation including technical staff and controllers continuously follows up to ensure that the vehicle maintenance department carries out its assignments as agreed.

In Mumbai we plan to set up almost the same model as in Stockholm for follow up of vehicle and infrastructure maintenance.



disruptions to services that have occurred during the preceding week. Since the delineation of responsibility is somewhat different in Mumbai compared to Stockholm, we propose that a representative of the highway authority in Mumbai should also participate in the meetings in Mumbai – in any case during the first year of routine operations. In Stockholm, contact with the highway authorities is normally taken care of by the infrastructure maintenance representative responsible of the trainway service.

Daily reports (computerised logs) from the control room are used as a basis for the discussions at the Stockholm Performance Meetings. The staff at the control centre compiles these reports. We intend to apply the same principle in Mumbai. Reference should also be made to sections "Performance Management Information and Operating statistics.

Ticket vending machines

In order to ensure quick and efficient service with regard to ticket sales, Connex will have to follow trends closely with regard to journeys made from the various stations so that customers do not end up in a situation where they are unable to buy a ticket before boarding the metro because there are a lot of paying customers waiting at the same station. It may thus be necessary to expand the number of ticket vending machines at certain popular stations, even if we already know that major stops are equipped with several ticket vending machines.

19.4 Safety at metro stations

There are special requirements as to the alertness and risk-awareness of the drivers. We will make a point of examining different station even at the construction stage as and when they are completed to try to identify and deal with any station that for various reasons could pose a particular risk

Notwithstanding various technical and structural precautions, special attention will have to be paid to these risks, primarily during the initial period of regular service, but also continuously during the entire contract period.



19.3.12 Punctuality

A high level of punctuality implies that the metros must come at the stated time. By its very nature, a basic prerequisite for a high level of punctuality is "a high level of reliability". If no metro comes, then it cannot be on time, either. The same factors that are important for reliability are also important for punctuality.

Connex has extensive experience of working towards achieving and sustaining a high level of punctuality. On the new light train in Stockholm, for example, punctuality reaches over 99% despite the fact that approximately 25 % of the line is running on-street with no separation at all from other road traffic.

19.3.13 Connex Mumbai Metro Service Manual

In order to ensure that our drivers and other personnel in Mumbai work according to the same uniform principles when it comes to ensuring a high level of traffic safety and a high level of punctuality as well as good customer service, for example, we will prepare a special adaptation of the Connex Service Manual that we work to in Stockholm, for operations in Mumbai.

The Connex Mumbai Metro Service Manual will be an important tool for handling the "soft questions" in a uniform way within the Connex metro service in Mumbai.

Please also refer to "Customer Service", where we append an extract from the Stockholm Connex Service Manual.

19.3.14 Operations Performance Meetings (OPM)

When it comes to monitoring factors (external and internal) that are important to operational safety, reliability and punctuality and other customer service we intend to set up the same type of weekly Performance Meetings in Mumbai that have been successfully applied in Stockholm since Connex took over operations there in the summer of 1999.

At these meetings, those responsible from the operations department, commercial department, vehicle maintenance and infrastructure maintenance meet and review any



19.5 Line Performance

19.5.1 Line Capacity

The maximum line capacity is defined as the number of passengers per hour per direction (pphpd) that can be transported past any point on the line, in the peak period in fully occupied trains operating in the peak loading condition.

The line shall be built for a maximum capacity for 39500 pphpd operating the train service at 3-min headway up to year 2041.

19.5.2 Operational Headway

The practical headway between trains is a determining factor in terms of system capacity. In order to secure an acceptable operating flexibility margin and attaining a general comfort level to passengers. The practical headway between trains will be higher than the critical part of the theoretical rail line and train equipment design. When a rail line is operated based on theoretical headway between trains, the smallest incident may result in delays along the entire rail line.

Adjusting the line transportation capacity to the future passenger traffic requirements will be obtained by modifying the headway.

The necessary frequency of trains (required number of trains per hour) and the relevant operating headway is determined according to the estimated passenger flow and the maximum number of passengers per train during peak hours. The hourly ridership forecast must be lower than the proposed hourly train capacity supplied.

19.5.3 Dwell Time Requirement

The duration from the stopping time of a train at a station until its departure from the same station (traction propulsion re-applied) is the Dwell Time in a station. The dwell time includes the technical time corresponding to the opening and closing of the train doors. This duration includes:

Transfer time: Passenger boarding and alighting time (based on station traffic, doors width



and configuration characteristics),

Technical time: Door opening preparation time, the door opening time, the passenger warning time upon the door closures and the door closure time

The calculation of dwell times in stations is then based on:

- Station traffic characteristics (passengers boarding and alighting),
- Train door width (number of lanes),
- The passenger flow rate at doors and,
- Headway required between trains.

An average **20s** dwell time is recommended for all intermediate stations due to the anticipated higher passenger flow forecasts. The dwell time will be more important at certain stations like Versova, Andheri, Saki Naka and Ghatkopar.

19.6 Service Line Speed

19.6.1 Acceleration / Deceleration Characteristics

The acceleration and deceleration characteristics of the rolling stock help to determine the best possible run times. The braking capability of the rolling stock is mainly limited by the tolerance of riders (especially standing passengers) as far as high deceleration rates are concerned. Passenger discomfort can also result from high acceleration rates especially high jerk rates (i.e. rapid changes in the acceleration or deceleration rate). The acceleration rate also enhances the railway system performance results.

There are very few ways to accelerate a metro vehicle:

- Increase its speed
- Reduce dwell time

Obviously the action on speed is quite impossible except if the speed would be voluntarily reduced for all vehicles, which is not advisable and would impact negatively the image of the Metro. This is to our knowledge only used on fully automatic metros.



The action on dwell time is possible within certain limits but only if the vehicles have the function of time-counting down from opening doors with possibility of variation between normal and reduced time. This is used in metros where doors open altogether at the same time.

Efficient operating control system able to monitor early/late running vehicles (early running vehicles must be slowed down which is not a difficulty)

One may recognise that if not handled this way (with the possibility to accelerate a late vehicle), the only way to ensure a "stable" system is then to retain all vehicles if a vehicle is delayed. This is another type of regulation (headway regulation) which is commonly used in full automatic subways and sometimes, but less frequently, used in regular subways (because it creates a complete disruption to the drivers' time schedules). In addition, it is costly (the average running time is higher and the regulation creates overtime for drivers). Also, it often goes together with having to have a reserve vehicle and driver at each terminus (which is difficult to afford) and finally it is not very well accepted by passengers who do not appreciate seeing the vehicle where they are just stand by and wait "for regulation purposes". Lastly, having a full headway regulation results in losing a part of the production, which is also a negative aspect of service.

We may understand that the hereby proposed system may not presently be fully matched to the existing functions and technical solutions of the vehicles and system, but we understand also that the operator will be given an opportunity to participate in the creation of the system and will give his commitment that he is satisfied that the system is capable.

Our understanding is that the Client is targeting a high level of reliability together with a maximum use of the performance of the system (not reducing the capacities of the vehicles). We therefore propose to work on the technical solution able to reach the targeted aim thinking that everybody, as we do, will refuse to have a system in Mumbai with poor quality.

19.6.2 Service Intervals

Intervals between trains are given in "Schedules to Operating Contract" section. Connex will operate the service in accordance with these intervals and will monitor compliance.



Our judgement is that this will also be possible provided that, above all, the technical systems support operations and function as intended.

The actual intervals between trains are affected by several different factors:

1. The driver
2. The passengers

When it comes to passengers' influence on intervals and punctuality, it is imperative to have a rapid, smooth flow when it comes to both boarding and alighting from the metro. The trains are also conducive to a smooth and prompt flow of passengers by virtue of their having many doors, which are also generously proportioned. The fact that the trains also provide floor-level entry further contributes to rapid and smooth calls at the stations. In our judgement and experience of similar services, slow passenger interchange at stations would only marginally affect service intervals and punctuality. Nevertheless, there is a risk factor, which must be taken into account.

Last but not least, the driver's professionalism is an important factor contributing to a high level of punctuality and maintaining service intervals. By following the information provided by the OCC and adjusting his driving in different ways, the driver can considerably influence punctuality and maintain service intervals. If the train is running ahead of schedule, it is important for the driver to be aware of this and not just drive on, only to run even further ahead of schedule. If the train is running behind schedule, the driving must be adapted accordingly, without sacrificing safety and comfort. We know from experience of both bus and rail services that the driver's style of driving also affects passenger behaviour. If the train is being driven in a calm and stable manner, without unnecessary jerkiness and braking, passengers alighting will feel it is safe to move towards the exit doors even while the train is still approaching the next stop. If, on the other hand, the driver is driving jerkily and making passengers uncomfortable, the opposite happens – stoppage time at the stop is increased, since passengers will remain seated until the train has come to a halt.

In its training programmes, Connex will place a great deal of emphasis on teaching train drivers not only a safe way to drive and react to traffic, but also how to adopt a style of driving that is comfortable for the passengers. These instructions will also be included in the Connex Mumbai Metro Service Manual.



19.6.3 Speed and Trip Duration

Speed is an important factor to attract passengers from other transportation modes. Increasing the maximum speed of trains will increase the commercial speed by only a small amount. More important factors determine the commercial speed of a system, i.e. the number of curves along the line and other physical factors affecting train operation (signaling implementation or rolling stock characteristics for instance). Therefore, rail line constraints and restrictions will be avoided wherever possible during the system design.

The average commercial speed has been estimated at 33 kmph with a maximum speed of 80 kmph. The travel time primarily depends on line length, number of stations, distance between stations, halt time at each station and dwell time at each terminus station. This speed can be considered as a reasonable objective, provided that operating conditions are not altered.

19.6.4 Fleet size and train size

The total number of vehicles required for the services of the line is determined by the time it takes for a train to complete a full cycle on the respective line (counting from the departure from one of the terminal stations to the next departure of the same train from the same terminal station) during a time of the day when the pressure on the service is at its greatest – that is, during rush hours.

Factors determining the combined "lap time" are the length of the circuit, the intervals between departures, the average speed and the time required for turning around at each terminus. The average speed depends not only on the maximum speed, on the acceleration and braking performance of the vehicles but also on stoppage times at metro stations.

The length of the line and the service intervals are known elements, which are also determined in the documents forming the basis for procurement. The average speed is, at present, estimated based on theoretical data from the technical performance of the vehicles and the track.



Total "lap time" is based on the assumption that at least 60 seconds turn around time must be allowed for turning the trains around at each terminal station.

The table below indicates, according to the headway, the size of the rolling stock fleet corresponding to the transportation capacity required. (Pl. refer Ch 10 for calculations)

	Headway	
	4 minutes	8 minutes
Operational headway	4 minutes	8 minutes
Trains in Operation	11	6
Spare Train for standing-by	1	1
Spare Train for Maintenance	1	1
Total Train Required	13	8

Design Parameters and Station Classification

The stations are classified in different groups in accordance to their anticipated daily passenger flows as well as the complexity of the nearby track configuration.

19.7 Crew Rostering

Connex has different computerised systems for Crew Rostering all over its world wide operations. The joint objective for all Connex Crew Rostering systems is to provide a structural and easy way to supervise and ensure that the right levels of manning for vehicle operation and other vital functions are obtained.

In traffic operation, which is on going almost 24 hours a day all year round, it is very important that no "gaps" in the manning occurs, causing a train to be without its driver or the Control Room to be without a controller.



This all requires, beside normal management and supervision, a reliable system for Crew Rostering able to take care of short term staff planning as well as medium term and long term staff planning. The Crew Rostering system is also often the first part of the preparation of payrolls.

The different systems for Crew Rostering used by Connex for rail operation even have the availability to take care of consecutive control to check that the staff with safety critical tasks have the right level of competence in terms of skills and knowledge as well as health examination rules. If the competence for a certain driver (or another person in a safety critical role) is due to run out, the system will automatically alert the manager and the Crew Rostering clerk in a certain number of pre-set days before.

Another purpose of the Crew Rostering system is to monitor that no person is working longer or in another aspect against the rules of law or working agreements between the Company and the Unions. Connex Crew Rostering systems have "alarm" functions even for this type of circumstance.

Competence

- Employee has the required knowledge & skills to undertake that work
- Employee fulfils all requirements according to Health Check
- Employees that fail any or the above checks will be presented to the Crew Rostering clerk (or other in charge of staff and planning) with the reason why they have failed.

Working time and Rostering Principles

Working rules

Master Rosters will be constructed so as provide for an average working week according to the agreements in Mumbai between Connex and the relevant Unions.

For example a maximum number of working hours per day and per week will be set in the agreement together with a maximum number of continuous working days between rest days (even including over time). Even a minimum rest period in hours between duties (working days) will be set.



Spares

The Crew Rostering system will, in the long and short term, also be used to secure the right number of spares to meet, for example, the following needs:

- Special trains
- Route and Traction Training
- Sickness
- Leave commitment
- Miscellaneous authorised absence, jury service, staff representational duties etc.

Posting of Rosters

As the special staff agreements for India and Mumbai, as mentioned above, is to be set later we here gives a short description of present principals concerning as an example "Posting of Rosters" and "Sickness Arrangements" in Connex Sweden.

Master Rosters and any subsequent permanent alteration thereto will be posted in depot notice cases 7 clear days in advance of the first day of operation. In exceptional circumstances Management may seek agreement at local level to allow posting less than 7 days, where the business would otherwise be severely affected.

Weekly Rosters containing all known commitments will normally be posted in depot notice cases by 12:00 hours on the Thursday preceding the week of operation.

Daily Alteration Sheets to the weekly rosters to take into account subsequent changes shall normally be posted in the depot notice case by 12:00 hours on the day prior to the day for which the sheet applies.

If a driver (employee) has completed a days booked work and the daily sheets are unavailable and there is no information available from the operations team leader as to what the next days work is, it will be the team leader's responsibility to advise the driver (employee) of any alteration.

Public and Bank Holidays rotations will be posted in the depot notice cases 7 clear days in advance of the day of operation.



19.7.1 Sickness Arrangements

Reporting sick or Resumption

Employees must advise their operations team leader of their inability to attend for work due to illness, at least 1 hour prior to the commencement time of their turn of duty unless exceptional circumstances prevail. They must give an indication of when they are likely to resume duty.

Employees must advise their operations team leader of their intention to resume duty following illness, by 12:00 noon, the day prior to resumption and ascertain their next turn of duty.

19.7.2 Crew changeover facilities

Connex intends to have all normal changeover for train drivers and other personnel taking place at the depot. This way, the drivers will also have access to the facilities available in the depot buildings. At the depot, there will be special staff rooms set up where drivers and other personnel will be able to relax in peace and quiet during breaks.

The staff room will be equipped with comfortable furniture and armchairs, both for relaxing and for chatting with colleagues. To ensure that those who really want to rest can do so undisturbed, there will be a special room at each depot reserved for "silent relaxation", away from TV sets and radios, for example. The local operational management will also use the staff-room facility, creating positive, natural contact between drivers and operational management.

19.7.3 Personal needs / Meal breaks

As the preceding section shows, areas for toilets and recreational staff rooms will be set up and located at the changeover points in the depot. In the same way, facilities will be provided at the staff rooms to store and prepare or heat up food that has been brought along. Ovens, microwave ovens, refrigerators and worktops will be arranged to sufficient extent to eliminate the need for people to queue up.

19.7.4 Performance Management Information

As already stated in point "Service standards Connex intends to apply basically the same system of Performance Management Information as we do at Connex in Stockholm. The system is essentially based on the reports and information coming into the control centre, partly technically via the various technical systems and partly verbally via the train drivers and mobile personnel. The controller logs all abnormal operations in a computerised logging system (Incident Report Log – IRL), which enables all incidents to be searchable in a database and makes it possible to produce statistical reports.

The information in IRL forms the basis of the weekly Operations Performance Meetings (in Stockholm, lasting approximately 2–3 hours), which Connex intends to implement, together with other information from those responsible for vehicle maintenance and infrastructure maintenance.

Prior to each Operations Performance Meeting, the various disruptions of the previous calendar week are compiled from IRL. All disruptions, including disruptions of order and any personnel or vehicle shortages (traffic stoppages, major delays and cancelled services in the form of cancelled departures, hours and kilometres per vehicle) are assigned to the department primarily having responsibility for it (Operations, Commercial, Rolling Stock [Maintenance Contractor] or Infrastructure [Maintenance Contractor]). Some disruptions that are rare and out of the ordinary and are beyond the control of Connex and its partners can be attributed to Force Majeure instead of being assigned as the responsibility of a department (unit). Depending on the nature of Force Majeure, however, the department (unit) most closely connected will be assigned the task of following up on the incident in order to prevent its repetition if possible.

During the Operations Performance Meeting, all events are addressed point by point. If necessary, the information as to which department is responsible for a particular incident is changed. Since the preliminary Performance Report is circulated the day before the meeting, the manager responsible has the opportunity to check the cause of a particular disruption and report on this at the meeting, including what measures his department is taking in order to prevent similar incidents from occurring again. If the cause of a disruption cannot be ascertained without further elucidation, the incident is assigned to a



balance list, containing information on the department primarily responsible and the person responsible for further elucidation.

No case will be taken off the balance list until the final cause of the disruption has been ascertained and the department ultimately responsible has been determined.

The Performance Reports, as endorsed at the Performance Meeting, are compiled into a monthly Performance Report. This forms the basis of the financial balance between the various partners (allocation of fines, etc.).

The monthly Performance Reports are distributed to the Connex management team. In the event of systematic and repeated shortcomings being included, the department manager in question will be given the task of producing an Action Plan in order to deal with such problems.

The intention is to convey information as to how operations are functioning, as well as current statistics, to the staff by means of weekly local information sheets and company-wide staff information.

19.7.5 Operating Statistics

Operating Statistics are obtained on the one hand via the IRL reports described in section "Performance Management Information" and, on the other, via the AVLS and other various logs (or similar) of the technical systems for following up on Mumbai Metro operations. This is in addition to Connex internal system for following up on the status of staff training and in-service training as well as staff qualifications with respect to knowledge and medical issues.

Operating Statistics can be divided into six main sections:

- Operational aspects
- Technical aspects
- Production aspects
- Customer service aspects
- Safety aspects
- Human resources aspects



Operational aspects include non-technical disruptions, incidents and near-accidents and could, for example, be a matter of staff shortages, incorrect or neglected measures by drivers or other staff, etc.

Technical aspects include disruptions and incidents of a technical nature where various technical systems of train operation on the vehicle or fixed installations along the track in any way cause disruptions or near-accidents.

Production aspects affect statistics in the sense of services carried out and expressed as kilometres per vehicle and operated hours per vehicle in relation to planned production – as well as maintenance output in respect of vehicles and installations in relation to planned output, and the number of train journeys, including ticket revenue, in relation to planned (calculated) journeys and planned (calculated) revenue.

Customer service aspects including complains and proposals through to the "Customer Hotline", letters and emails.

Safety aspects cover statistics concerning actual accidents and near-accidents, departures from normal procedures in the interests of safety that did not cause near-accidents, but could have done so under slightly different circumstances.

Human resources aspects concern follow-up and ongoing monitoring of the status of staff training and in-service training as well as staff qualifications with respect to knowledge and medical issues.

19.7.6 Normal Operations

To achieve the greatest flexibility for normal (and abnormal) operation we intend to operate the line as a single entity, which is already suggested by the existence of one control room, with operating, depot, maintenance staff able to be assigned to any location on the network.

19.7.7 Control Centre Operation



The Connex organisation is performing successfully in controlling the operation of train services, in addition to having long experience of this. A basic prerequisite for effective disruption-control work such as providing accurate information to the customers is having successful and established action plans for various types of traffic situations. Connex controllers must have a flair for rapidly switching from a monitoring and preventative traffic control role to a proactively remedial one of disruption-control.

Following a successful model from Connex in Stockholm, the Mumbai traffic control organisation will also comprise a mobile unit, providing recovery operations, as described below.

When recruiting, the suitability of the applicant for the role will be assessed with the help of several variables. The selection process will include a work-psychology test.

Controllers' shifts are regulated by a work rota that allows for good changeovers and debriefing at the end of each shift.

19.7.8 Control Room

The Mumbai Metro control centre (situated in the depot) will take care of the ongoing monitoring of the metro service via various technical systems and will keep in contact by radio and telephone with the train drivers, the mobile personnel and the metro service vehicles. The control centre will also monitor the metro service via the CCTV systems that exist along the train line as well as answering and dealing with calls via the emergency call system at the train stations.

The control centre will also be responsible for monitoring the other technical systems relating to the metro service such as the power supply and signal installations, in addition to lighting, as well as ticket vending machines at the metro stations.

The controllers on duty are also intended to serve as the train driver's and mobile personnel's immediate operations managers in operational service. This implies, for example, that the controller has the right to decide to withdraw staff from service if required in connection with a serious incident occurring or a near accident, or, for example, on suspicion of the influence of alcohol or other intoxicant. This right also covers all maintenance personnel.



The Operations Control Centre OCC normally handles the trains (multiple-unit vehicles) in service on the line. Our assessment, based on experience of other similar services, is that the Control Centre should be staffed with controllers 24 hours a day, every day of the year. Additional Controllers may be needed during rush hours, mornings and evenings and during daytimes on weekdays. Operational experience will show whether or not additional controllers will also be required at other times and on other days of the week. Additional controllers will also serve at the same time during special events and major maintenance or repair works along some of the lines, when additional monitoring will be required.

During the night-time hours when metro services are not operating, the controller will compile the incident statistics of the previous service day, including disruptions, producing a finished "daily report" based mainly on IRL (see above) and the information supplied via various technical monitoring systems (logs). The controller will also prepare for the next day's services by ensuring availability of vehicles through constant contact with the vehicle maintenance personnel at the depot. In parallel with this work, the controller will also monitor the operation of the technical systems and respond to any emergency calls from the train stops during the part of the night when services are not operating.

Staffing the control centre with qualified controllers, even when no services are operating (during the night), ensures that incidents that may occur during these times do not remain without remedy until services resume the following morning, with consequential risk of disruptions.

Ongoing work of the control centre and lines of communication

As already stated the ongoing work of the control centre entails continuous monitoring of train services via the technical surveillance systems and via radio contact with the train drivers. An important aspect of the ongoing work is the anticipation, identification and understanding of those conditions that, further ahead (reckoned in minutes and hours), could disrupt operations. These might include suspected vehicle faults, suspected faults in other technical equipment, indicated personnel problems or indicated external disruptions; hence preventive and corrective action can be taken as early as possible.



In order to be able to respond quickly when necessary, well-established lines of communication with key functions including those outside of Mumbai Metro are needed, such as with the police, fire brigade and ambulance services as well as the relevant highways authorities. Connex has extensive experience of setting up such well-functioning relations.

By its very nature, the work of a controller is sometimes quite calm, then very quickly it could require the full attention and engagement of the controller. Connex places a great deal of emphasis on recruiting controllers who are capable of handling these rapid changes in levels of activity.

Technical assistance to drivers

Our intention is for all controllers also to be trained and qualified metro drivers, in addition to having greater in-depth technical knowledge of the vehicles and installations than is normally required of each train driver. In this way, the controller can act as the first line of "technical assistance" to the metro drivers in the event of disruptions due to vehicle faults or other technical faults along the track. We also have very good experience of this model from our service in Stockholm (both light train and underground). The model of having controllers who are qualified drivers also implies that all controllers, at certain specified intervals, serve as train drivers for a day. This also serves to keep the controllers up to date on what is happening "out in the field", which increases the understanding between drivers and controllers.

Since the controller only provides verbal assistance to the drivers via communications radio or telephone, in the case of more complex and service-stopping technical faults, appropriate resources also need to be dispatched by vehicle to the scene of a disruption. Connex will co-ordinate such resources with the respective technical subcontractor.

19.8 Remediating disruption

An important task over and above the ongoing, somewhat "passive" monitoring and managing of services and monitoring of various systems is rapidly taking in hand and remediating disruptions that arise in the system. Disruptions may be either technical or non-technical in nature or may relate to staff failures and accidents or near-accidents. A



statement of our basic principles in respect of this is reproduced in section "Abnormal Operation" below.

19.8.1 Daily Vehicles Operations

Day-to-day operation of the trains is based on several aspects working in tandem. A basic prerequisite for being able to operate and offer passengers a disruption-free service in accordance with pre-determined plans is for the vehicle maintenance contractor to deliver vehicles that are fit to drive, presentable and roadworthy, at the right place and at the right time. As stated above, the controller on duty is responsible in the short term (the last few hours before going into service) for checking and ensuring that the right number of trains will be delivered by the Maintenance Contractor at the right time and in the right place.

19.8.2 Start of transport services

Normal procedures used by most public transport operators involve drivers coming on duty going through a standardised overall checking of their assigned vehicle before it leaves the train depot. This happens even if the vehicle has been supplied with the individual information that it has been fully "prepared" for service by the technical department. A final check will be necessary before leaving from the depot.

The following points should normally be included:

1. Give driver and line/route specific information (in-put).
2. Check that the train can be driven from both drivers' cabs and that the controls for the manoeuvring and monitoring systems, including communications radio, in both drivers' cabs are working.
3. Check that the starter-equipment and braking equipment work error-free, that there is sand in the sanding devices and that these are working.
4. Check that all passenger doors are working normally.



5. Check that interior and exterior lighting is working, as well as the passenger information systems.
6. Check that the passenger area (including the seats) is flawless.
7. Check that the train has been properly cleaned and that there is no graffiti.
8. Check that the appropriate passenger information is made available in the vehicle.

19.8.3 During the service day

During the service day and when out driving on the line, the driver must be aware of his train and, in the event of faults being suspected, try to investigate as soon as possible whether the fault can be remedied and whether imminent faults can be averted. If necessary, the driver must immediately report any problems to the controller and consult with him as to how the matter should be resolved. If necessary, the controller can send technical personnel to investigate a fault that the driver is unable to remedy.

At regular intervals during the service day, the driver must check that the sanding devices are working and that the required amount of sand is in the sand containers. The driver must also follow up to ensure that the train is working normally as well as that the passenger area is kept in a good and presentable condition with regard to cleanliness and being free of waste.

During changeover of personnel in the course of the service day, both drivers must exchange information as to the status of the train, including any faults or shortfalls.

19.8.4 End of each service day at the depot

When a train is to be taken out of service and driven into the depot, at the last stop before the depot, the driver must check that there are no passengers remaining on the train. On arrival at the depot, the same check must be carried out again, with the driver also checking that passengers have not left any items on the vehicle. If passengers have inadvertently been brought to the depot, it is the responsibility of the driver to ensure that they are appropriately helped out of the depot area. Any train faults must be reported in writing to the depot personnel before the driver leaves the train.



According to the washing plan and washing policy, the driver will drive its vehicle through the washing machine before leaving the train.

19.9 Depot Operations

Depot operation for Connex as the Operator within the Mumbai Metro scheme can be divided into different parts, here beginning, as an example, with the train arriving to the depot after a day of operation to be prepared for the next day of operation without special maintenance work:

- **Instructions.** First of all on arrival to the depot, the train driver will be given information by the controller where to park the train after certain activities, given by the controller at the same time (below).
- **Washing.** Connex drivers are responsible for driving the train through the train washing machine in the depot when instructed to do so by the controller on behalf of the maintenance department.
- **Filling of sand.** In addition to washing, Connex drivers are responsible, on all arrivals to the depot after more than five hours operation, for filling up sand in all sand boxes of his train or trains.
- **Parking.** After fill up of sand and (when requested) even washing of the outside of the train, the driver shall drive his train to the appropriate parking track.
- **Preparation for next running shift.** During the early morning hours or late evening and night the train will be checked and prepared by the maintenance technician following a special checklist. Depending on how many running hours have elapsed since the last overhaul the technician will use different checklists to fulfil his work. When ready a special form will be signed by the technician and placed in the drivers cab including a copy to the depot logbook.
- **Drivers last check before departure.** All drivers taking a train out from the depot on a working day will follow a special a standardised overall "drivers checklist".



- **Instructions and leaving the depot.** When ready to leave the depot or depot yard, the driver asks for instructions from the controller. The controller ensures that the train will be let out on the line in the appropriate direction and at the appropriate time.

19.9.1 Vehicles movements within the depot area

All movements within the depot areas (as well as on the line) will be supervised and controlled by the controller.

Connex will provide drivers (shunters) for the necessary movement of the trains within the depot on the behalf of the vehicles maintenance department.

19.9.2 Maintenance activities in the depot

A proportion of the fleet of vehicles will be allocated for examination, cleaning and maintenance in the depot. Diagrams will be prepared with sufficient time from arrival at to departure from the depot for the examination and maintenance to take place. The appropriate vehicles will then be allocated to the appropriate diagrams. Plans will also be prepared to ensure that staff working on vehicles do so safely, have sufficient personal protective equipment, training in the tasks expected of them and the tools and chemicals that they will use.

Provision will be made for storage of equipment and materials, environmentally friendly waste disposal and facilities for the staff to prepare and eat food. Plans will be made to keep these in good repair.

19.9.3 Normal Operating Procedures

The normal operating procedures are based mainly on three fundamental parts (preparation, implementation and conclusion) as stated above under section "Daily Vehicles Operation". The complete operating procedures for normal operation do, however, start earlier and cover more than just the actual management of the trains on a particular service day.



19.10 Preparations and Planning

The basis of the entire operation (normal and abnormal) is 1) long-term planning and 2) short-term planning (production of timetables and service rotas), 3) recruitment and 4) staff training and in-service training, 5) manpower planning, 6) planning maintenance of vehicles and installations as well as implementation of this and 7) planning and application of emergency plans for various types of abnormal operation.

1. **Long-term planning** (planning on an annual basis and longer) forms the basis and prerequisites for virtually all remaining planning. The long-term planning establishes the rough outline of future service arrangements, which in turn govern staff needs, recruitment and staff training in various specialist areas. Long-term planning is also the basis for planning maintenance of vehicles and installations, which to a large extent, but not entirely, depends on the scope of the service and thus the effect and wear and tear on vehicles and installations.
2. **Short-term planning** (planning on a monthly to half-yearly or seasonal basis) involves producing timetables (internal and general) as well as rotas for staff working shifts in the first instance (drivers, controllers, mobile personnel and maintenance personnel). The work set-up and work procedures for personnel not working shifts are also governed by short-term planning with regard to when vehicles and track installations are available for maintenance purposes.
3. **Recruitment** of drivers and other personnel is a basic prerequisite to enable agreed services to be carried out.
4. **Basic training and in-service training** are the two cornerstones of all staff training programmes.
5. **The planning of maintenance for vehicles and installations** is carried out by the contractor concerned, under the supervision of Connex. Connex will do this by examining current maintenance plans and individual job cards. Maintenance work carried out by Connex under its own auspices will be governed in the same way, using established maintenance plans and individual job cards.



- 6. **Abnormal Operation** is to be planned and handled in accordance with section "Abnormal Operation" below.

19.11 Implementation of the service day

Sign-in and Sign-off

Since Connex intends to allow all transport services and all personnel begin and end their working day at the depot all signing-in at the start of the working day and signing-off at the end of the working day will take place at the relevant depot. Thus, there will be no risk of a driver failing to turn up for the start of his shift without this being noticed by the operational management. At the start of service each morning, there will be an operations team leader at the depot who will take a register of all personnel who have reported for duty and received the required instructions and directions for the working day.

Reading orders and messages

In addition to the room (of the operations team leader) where staff reports for duty at each depot, there will be notice boards for orders and messages to personnel. All personnel must note any new orders or messages at the start of the working day.

Reserve personnel

There will be sufficient numbers of reserve drivers at the respective depots during the entire service period. It is planned that in the morning, the reserve driver will arrive at the relevant depot approximately 20 minutes before the first driver is due to begin his working day, and his first task will therefore be to have a quick look to see that all trains required for going into service have been prepared by the vehicle maintenance contractor.

Action taken by the driver during the service day

The driver's first action when he arrives at the depot is to report to the operations team leader and note current orders and messages from the operational management. A check of the assigned train will follow, as described in section "Daily Vehicles Operations" above.



Before leaving the depot, it is the driver's task to ensure that his train is ready for service, both from a safety point of view and from a customer perspective. If shortfalls are discovered in either of these respects, the driver must immediately report this to the controller, who must take the necessary action.

The driver has sole responsibility for the safety of his own train and for the security of passengers. In the event of any accidents the driver must inform the controller without delay. The driver must also inform the controller of anything that has, or could have, a negative impact on customers' experience of the transport network, such as disruption of order, damage, faulty equipment, etc.

At each stop where the train is turning, the driver must – if possible, with reference to the timetable – check the vehicle for any items left behind and any damage, etc., sustained by the vehicle.

The driver must drive the train with due regard to safety and comfort requirements and strive for even and calm driving without unnecessary jerks and sharp braking. The driver must as far as possible provide passengers with information and assistance, without neglecting safety or losing track of time.

Changeover during the service day

Drivers beginning their shift by relieving another driver "on the line" must previously have reported to the operations team leader at the relevant depot.

Drivers who for any reason are not replaced at the planned changeover time, may not leave their trains, but must report to the controller via the communications radio and drive on until changeover can be arranged. If the timetable allows time for a relief driver to arrive, this is what should be done after permission has been given by the controller, if it is still possible for the train to leave at the appointed departure time. Where the driver has to continue driving because changeover has not been effected, the relief driver may arrange to take over at a suitable stop, or else when the train returns to the depot.

Driving trains into the depot



When driving trains into the depot at the end of the service day, the driver is to apply what is stated in section 'Daily Vehicles Operations' above. Any faults in the train must be reported in writing to the operational management at the depot before the driver leaves the depot.

Different levels of Abnormal Operation

In addition to the typical cases of abnormal operation, disruptions can be divided roughly into two categories: *planned disruptions* and *unplanned disruptions*. Typical of planned disruptions are that in these situations, Connex has the opportunity to pass on information about the disruption in advance through notices and advertisements as well as planning how inconvenience to passengers can be minimised by means of replacement buses, arranged in advance for example.

Typical of unplanned disruptions is that they often occur without any warning in the usual sense, even though, for example, early signs of a vehicle fault or the start of problems with the power supply may give a certain amount of warning time before the disruption takes hold. As stated previously, it is therefore important for both drivers and controllers to be aware of vehicle or installations faults that could develop into stoppage faults.

Connex classifies emergency disruptions (unplanned disruptions) according to the following scale.

- Type 1 Disruption/fault that only needs to be reported for future action
- Type 2 Disruption/fault requiring immediate action w/out stoppage
- Type 3 Disruption/fault causing brief stoppage (5–15 minutes)
- Type 4 Disruption/fault causing longer stoppage (15–30 minutes)
- Type 5 Disruption/fault causing extended stoppage (over 30 minutes).

Our evaluation based on experience of train services with new installations and new vehicles is that the emergency disruptions (after an initial testing and trial period of approximately six months with all systems in complete and normal operation) are distributed as follows according to type of disturbance level :

- Type 1 approximately 85% of disruptions
- Type 2 approximately 10% of disruptions



Type 3 approximately 3% of disruptions

Type 4 approximately 1% of disruptions

Type 5 approximately 1% of disruptions

Potential causes of Abnormal Operations

Abnormal operations may occur in any type of operation. When it comes to train services, Connex has experience from operations in several different countries.

Causes of Abnormal Operations in train services might include the following:

- Vehicle faults not resulting in stoppage
- Vehicle faults resulting in stoppage
- Power outage
- Fallen overhead cables
- Disruption of order
- Bad weather

Potential Emergencies

Accidents can happen in any type of operation. Incidents more specific to trains include:

- Collision with a passenger on a station
- Collision with another train
- Fallen overhead cables
- De-railing
- Fire
- Sabotage

Connex has valuable experience of handling all types of Abnormal Operations and Emergencies.



19.12 Alternative Service Strategies

Purpose of control room

One of the main reasons for a Train control centre is to return the train service back to normal as soon as possible after a disturbance in a safe and reliable way. Its role is to deal with safety of the line issues from major collisions to a door on the catch in a method that is safe and laid down in rule books and safety manuals.

To advise customers, both internally and externally of problems with the train service and the subsequent alterations made to rectify these issues.

Strategies

It may sometimes be possible to run over Single line working (SLW) between the affected areas, thus allowing a train service to run throughout, but with a much reduced service pattern.

It may be possible to terminate short, depending on if there are cross-overs close to the disturbance, of the scheduled destination and cross over to the other line (track) and come back. Effectively terminating short. To cater for the passengers to the end of the line you can either pass on other bus routes or, as in Mumbai seems to be a better alternative, supply buses/coaches from public bus companies or private hire companies that will run exclusively between stations on the line(s) affected.

This is a much preferred method as it keeps passengers moving, though does take a while initially setting them up. But this obviously has constraints on it as well, like can you get coaches close to the station, turning circles and advice to customers etc. Obviously the park and ride facilities are the preferred locations to start/stop coaches.

As far as bus service replacements are concerned consideration should be made for time sensitive locations such as the railway stations and airports, running a fast bus from the city to the railway station and/or airport for instance.



With the depot being at the end of one of the lines this puts a great pressure on keeping this line open to ensure a service on all other lines. A great deal of maintenance and observation should be kept on the lines infrastructure so to keep it open for all movements.

To secure quick and efficient bus replacement in case of a disruption in the train operation Connex will arrange an agreement with local bus companies in Mumbai after the same model as in Stockholm and London, to pass anywhere within their area.

Service Recovery Strategies

Recovery Strategies are a part of the Connex traffic control organisation, the purpose of which is to handle emergencies encountered by vehicles in service and where qualified handling is required at the scene. Such incidents could, for example, be accidents involving people, fires, breakdowns, derailment, fallen overhead cables or incidents disrupting order as well as all other kinds of incident, for example vandalism.

Where train services are impacted by extremely serious incidents, it is of paramount importance to get specially trained staff to the scene quickly - people who can provide support to the train staff and the emergency services as well as generally contributing knowledge, backup and information.

Since train services operate alongside other modes of transport, there is a particularly pressing requirement for prompt intervention and other measures depending on the special risks involved, for example where an overhead cable is down.

Connex will have emergency services available 24 hours a day, either on duty in stand-by mode or on-call, including the period when train services are not running. This ensures prompt and competent intervention even if the cause of an incident is not attributable to the train service as such - for example, in the event of a road vehicle damaging the overhead contact line assembly at night, causing it to pose a hazard for people and other traffic.

On weekdays, from 5 a.m. until 1 a.m., at least one emergency vehicle will be available and manned. They are based at the depot, and will for some hours each day patrol the line in order to monitor and follow up on the transport service and drivers. At least one



emergency vehicle will always be on stand-by during train service running time or on-call to proceed immediately to the scene of a disruption or accident.

The emergency vehicles will be manned by traffic supervisors with competency as controllers and train drivers, fully qualified to move and drive a train if necessary, for example in connection with an accident, as a result of which the driver is unable to continue driving.

Emergency vehicles

Under for example Swedish and German road traffic legislation, as well as that of some other EU countries, train companies are entitled to equip certain service vehicles with the same type of alarm signals as are used on fire engines and police cars. This type of alarm signal arrangement makes it possible to get the right personnel to the site rapidly, in the event of an accident or a serious disruption to traffic, to remedy the disruption, including situations in which street traffic is more or less at a standstill as a result of traffic jams (perhaps due to a train blocking the traffic). The reasoning behind these "special alarms" on some of the train operator's service vehicles is that accidents involving trains, or other serious traffic disruptions involving the train operator's vehicles, often require specialised technical competency not normally found within the community's ordinary emergency services.

Connex intends, with Stockholm as a model, to apply to the relevant authorities in India with regard to such entitlement. Even without the possibility for such "special alarms", we shall use the system with "emergency services" mobile by intervention cars.

Restoration procedures

The procedures relating to abnormal operation in Mumbai are to a large extent based on the experience Connex has of similar train services in Rouen and Stockholm, but are also drawn from our experience of railway transport operation. Typical of train services in comparison to bus services is that train services often mean a total stoppage of all services in a certain direction (or both directions) past the scene of an incident. However, "stoppage" in terms of a bus service often only affects one vehicle and the train service (as stated above) also requires specialist and qualified knowledge in order to prevent exacerbation of the damage or hindrance that has occurred. In all situations, it is of course



We are assuming that the tracks, as well as track devices such as the vehicles, are manufactured in accordance with accepted and proven methods, suitable for the circumstances in which they are to be used. Thus, normal and also occasionally difficult weather conditions must be coped with without breakdowns.

Wind and storms

Winds of sufficient force to hamper train traffic are not likely to occur. In very adverse conditions of strong, gusty winds, the pantograph on the roof of the train may be exposed to extreme stress. In these circumstances, it may be necessary to reduce the maximum permissible speed of the trains temporarily.

There is also a risk of strong winds bringing trees down across the track and the overhead contact line. Connex will draw up procedures that will, as far as possible, identify and remove such trees and similar obstacles posing a potential risk for Mumbai Metro in conditions such as strong winds and storms.

19.13 Abnormal and Emergency Operating Procedures

Below are some examples of procedures for handling Abnormal Operations and Emergencies. In all situations it is compulsory to immediately alert the Control Centre.

Driver assistance

Technical first-line assistance for train drivers in the event of a disruption that the driver is unable to remedy on his own is provided by the controller via the vehicle's radio or by mobile phone. Since Connex controllers are also qualified train drivers with supplementary training in train technology, prompt assistance is assured.

Faults resulting in stoppage

Stoppage faults mean that the train cannot be driven any further (within 5 min. [level 2 to 4 see Part "Abnormal Operation above"]) +without some kind of repair. Our experience from Stockholm indicates that stoppage faults are rare (2 stoppage faults per 100 vehicle faults).



In the event of a stoppage fault, one of the Connex emergency vehicles will in all cases be dispatched to the scene immediately. If the driver is not able to remedy the fault with expert advice from the controller, another controller and/or repairman will be at the scene within a short time to assist the driver.

In the event of such faults being so complex that the train driver and the controller are unable to fix them, vehicle technicians from the vehicle maintenance department will also be called to the scene.

Recovery of trains

In certain cases, faults may arise that require the broken-down train to be towed from the scene by another train. Although recovery should be regarded as an extreme measure, this can be considered as a last resort at times.

Lifting trains

It may be necessary to lift a train in the event of an accident where a person or a large object has been run over. Lifting trains may also be required following derailment.

Accidents

The fire brigade carries out the raising of trains in the event of an accident occurring which involves a person who has been run over and is trapped. Connex personnel will assist the fire brigade in the rescue work and will remove the train involved in the accident following the rescue effort. There will then follow technical checking of brakes, etc., in consultation with the police.

In certain cases, the fire brigade may also be able to raise a train that has run over a large object that cannot be dislodged other than by lifting the train.

Derailement

In the event of derailment where no one has been injured, the train will be lifted back onto the rails by the staff of the vehicle Maintenance department. The vehicle maintenance



department's staff may also raise a train in the event of an object having become stuck, but not normally in the event of an accident involving personal injury.

Fallen overhead cables

In the event of a fallen overhead contact line, it is important to ensure as quickly as possible that the fallen overhead contact line does not cause injury to persons or damage to property. In the event of an alarm (via a technical indication or a verbal alert) concerning a fallen overhead contact line, Connex will immediately dispatch an emergency vehicle to the scene and, at the same time, effect emergency disconnection of the power to the line for the section of track in question. Trains approaching the scene of the disruption are alerted via vehicle radio and ordered to stop at a safe distance from the site of the fault.

For repair of the faulty cable, the next stage is to immediately alert the repair staff from the Maintenance department.

Collisions with passengers

Collisions between passengers and trains must be prevented and avoided as far as possible. A collision between a passenger and a train can easily have devastating consequences.

When it comes to a collision with passengers, Connex goal is that this must not happen at all. In its driver-training programme, Connex will place a great deal of emphasis on the safety of unprotected road-users. The express goal must be zero serious accidents involving unprotected road-users; our experience from Stockholm also shows that this is an attainable goal.

In the event of a collision occurring with an unprotected road user, extraordinarily prompt and proper action must be taken. If the person in question is stuck under the train, it is a good rule of thumb to evacuate the train via a part of the train other than where the injured person is lying, partly to avoid unnecessary distressful visual impact to passengers and partly to "relieve" that part of the carriage that the injured person is lying beneath.



Connex will carry out special exercises with the Fire Brigade and Police in Mumbai to prepare for this type of accident, which we know from experience, can be extremely distressing to all parties involved.

Collision between trains

Connex experience is that collisions between trains are comparatively uncommon. Some train systems ensure (either partially or fully) that headway is maintained between trains using railway-style signals, sometimes supplemented by Automatic Train Protection (ATP). In other train systems, the trains are driven, as in Mumbai, "by sight" – that is, basically in the same way as cars. Connex has experience of all three variants of traffic solutions.

The risk of damage is greatest in a "head-on" collision between trains. This risk of collision is greatest if the train system includes sections of single-file track. The Mumbai Metro train network is entirely double track, which virtually eliminates the risk of high-speed head-on collision between trains. It is actually only within the depot areas and at the crossing points at a terminus that head-on collisions can occur. Common to these locations is the fact that speeds are relatively low.

Another type of collision between trains is driving into the back of another train. This type of collision can be rather serious and Connex will place particularly strong emphasis on this in its driver-training programme. Collisions due to driving into the back of another train may occur especially when leaves are falling in the autumn.

Fire

Fire puts special demands on resourceful action on the part of all concerned. All experience shows that one of the most important first steps in the event of fire is to disconnect the power. Many fires aboard trains start with the electrical equipment and can be extinguished quite easily if the power is disconnected. Even if the fire does not start from the electrical equipment, all power must be disconnected in order to be able to carry out fire extinguishing safely.

In the event of fire, it is important for passengers to leave the train as quickly as possible. However, this must be done in such a way that the passengers are not exposed to new



risks, for example trains on adjacent tracks or road traffic outside the train. Depending on the whereabouts of the train, the train driver must decide on how best to carry out evacuation safely. In disaster situations, the passengers may evacuate the train spontaneously and without direction from the driver. In such a case, it is important for the train driver to inform the controller immediately so that other trains can be stopped.

Sabotage

Sabotage to trains may consist of several different actions. For example, large objects may be placed on the track or stones or other objects may be thrown at the train. Attempts set fire to a train or start a fire along the track can happen, as well as various attempts being made to affect various technical systems.

It is important for all personnel to always be aware that sabotage may happen and to be aware of anything that deviates from the norm and to report these to the control centre.

19.14 Staff care

Within its various companies, Connex has tried and tested procedures for caring for staff who have been involved in an accident or some other serious incident. The general rule is that a driver who has been involved in an accident or some other serious incident is to be taken off duty immediately. The driver will only be able to return to work once a doctor and the driver's immediate supervisor have given their approval.

In certain cases, supplementary training and renewed aptitude testing may be required before a return to safety-critical work can be approved.

19.15 Special Safety investigators

Based on our experience from Stockholm, we intend to provide special training for a number of Connex staff as special *safety investigators* in order to be able to document the event at the scene of a serious near-accident professionally. These people will then be responsible for Connex internal investigation of an accident or a near-accident in parallel with the police investigation. In Sweden, the Swedish Railway Inspection Service trains special investigators for the various railway companies in the country and throughout the Nordic region. We will propose that the same type of training should be arranged in India.



They will act under the supervision and control of the Safety Engineer, following the Connex RISK AND CONTROL EVALUATION PROCESS (see next page).



Risk And Control Evaluation Process

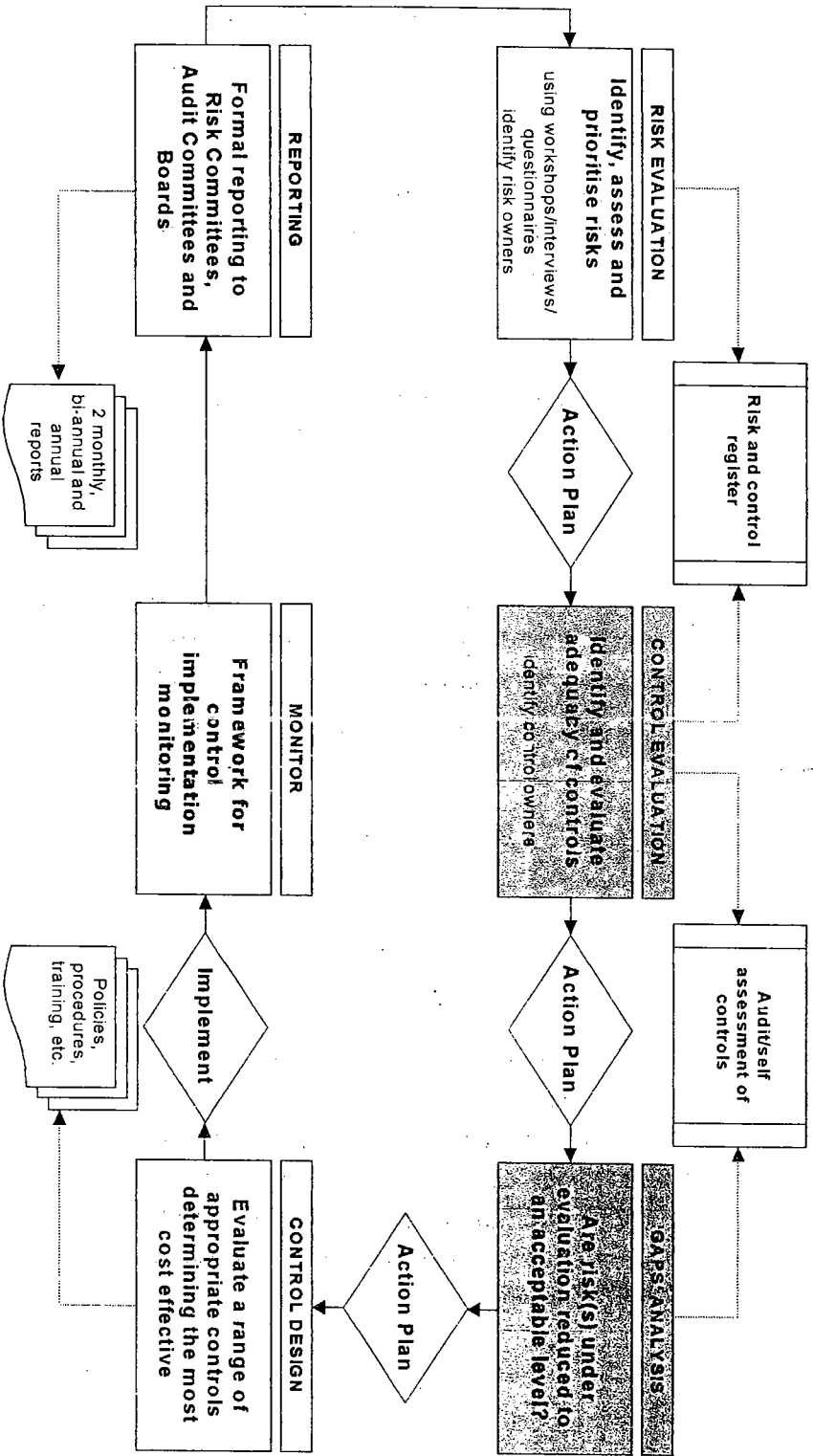

19.16 Personnel

We select staff for Revenue Control duties extremely carefully. In particular we seek extremely good communicators, who are well presented, professional and relaxed people, able to deal effectively with difficult situations and prevent possible conflicts. We also place great emphasis on the need for our staff to act firmly but with common sense to ensure that at all times, customers feel they are being dealt with in a fair manner.

In addition to receiving our Customer Service Training Programme, all staff and managers involved in regular Revenue protection activities will receive full training in the appropriate legislation relevant to the task. We also provide conflict-handling training for all such staff.

We recognise that this can often be a very stressful task so we set out to provide a role that is varied to reduce the time spent purely on Revenue Protection. A good example of this is in Stockholm's Metro system where we have merged the Revenue Protection and "Connex Hosts" roles to both provide a greater number of qualified control staff and to offer a Customer Service/Information providing role every other week to some of the Revenue Control Staff.

The principles that our Revenue Protection staff operate to include:

- A Customer-focused approach
- Professionalism at all times
- Firmness
- Autonomy and the use of Common sense

We also place emphasis on the links between ticket-less travel and potential crime or disorder. We believe that by having a high profile approach to the protection of revenue, whether through infrastructure, (gates, CCTV, fences) or through our personnel, those who could cause problems towards people or environments during a journey on our services will go elsewhere.

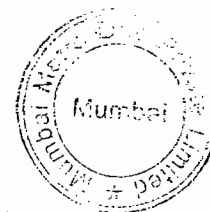

Communication to customers

In addition to applying a fair but firm policy to customers we also feel that it is important to explain to them why we need to ensure that passengers pay for their journey.

We have carried out many advertising and communication campaigns in our networks and will look into the need for such actions in Mumbai. The results can be both highly noticeable and financially interesting. Below we explain one example from Bordeaux.

Since 1996 the rate of ticket fraud in the city had increased to over 20%. The problem was, that this high level of fraud had repercussions both on the image of the transport system "there is no need to pay" and on the sense of insecurity. To fight this, Connex launched a major anti-fraud campaign.

Our first objective was to reduce the rate of ticket fraud. But we also wanted to change the behaviour of "redeemable cheaters", those who feel slightly guilty about not paying. Additionally, the image of ticket inspectors had to be improved. Finally everyone had to be put in a position to see that the company was dealing with the problem of fraud.

We strengthened the inspection team by adding lots of ticket inspectors. The inspection techniques were changed. This was considered as being effective for disrupting the habits of the people regularly cheating the system.

Probably the most important thing was the creation of a major advertising campaign to publicise the increase in ticket inspection, to give a positive image of the inspection. We also explained that the price paid for public transport was good value for money – as long as everyone paid. The campaign was held in 1997 and for a second time in 1999.

The main message of the advertising campaign was "if you cheat, you are not playing the game". This slogan was chosen due to the 1998 World Cup. It had a major impact as it used the theme of rules of the game that the referee has to enforce on a football field and which are essential for the game to take place satisfactorily. This theme enabled the ticket inspector to be seen as a referee rather than as a "cop".



The results of this marketing action were astonishing: 150,000 Euros of extra revenues for the first month and 1.4 million Euros of extra revenues over 12 months, an increase rise of 8.8%.

The cost of the second campaign was paid off within less than two months. In addition the general fraud rate in the network fell from 23% to 14.5% from 1996 to 1999.

19.17 Revenue collection

Connex Mumbai Metro will appoint an appropriate contractor to deal with collection of all revenues from ticket machines.

The experience gained with handling large sums of cash in our networks, where we are often responsible ourselves of all procedures and controls, will ensure that Connex Mumbai Metro keeps tight control over the contractor. Our specialists from some of our European networks will assist Connex Mumbai Metro staff in the selection of the contractor and the definition of the contract that will be entered into.

19.18 System Organisation and Staffing

Organisation

Mumbai Metro as an organisation reflects the highest degree of modern management thinking. Connex has combined the best of previously gained experience of operating transport services with the very latest in research into effectiveness and quality-creating organisations.

The organisation is process-oriented when it comes to routine operation of services, but is in other respects function-oriented in order to ensure that the train service has adequate management capacity both for normal operation and on such occasions when the organisation is faced with extraordinary stresses and in order to apportion responsibility for safety and the working environment at the right level.



Human Resource Management

Connex recognises that its greatest asset is its employees and that the continued success and growth of the Group is dependent upon the continued success and development of its employees. Connex encourages employees to use their own initiative to develop the business and overcome the challenges that face the organisation.

Connex promotes an open employee team environment with communication across all levels. A clear staff structure is defined in order for employees to understand their role in the organisation, their working relationship with others and the duties that they are tasked to perform. In return, employees are encouraged to develop their roles through training courses and continuous development. Connex is an equal opportunities employer.

Connex aims to develop a committed, harmonised and skilled workforce.

Connex Human Resources Policy

The main HR strategies to be followed by Connex are :

It needs to be seen within the context of the five key business objectives of Connex:

- Safety
- Customer Satisfaction
- Employee Satisfaction
- Performance
- Profitability

It sets out the overall strategy for Human Resources within Connex , and then develops the strategy into six key areas, against which there will be developed defined measures and targets (Measures of Success (MOS)).



Human Resources Vision

Connex aims to achieve three things through its Human Resources Function:

- Increase the commitment of our employees to delivering the Five Objectives
- Raise the "Human Capital" of the business through effective development of people, and ensuring that employees feel competent, capable and valued.
- Increase the performance of all employees in delivering the Five Objectives

In achieving these aims, it looks to work with its employees, managers, and other stakeholders in developing long term partnerships, which support the long-term success of the business.

Connex Mumbai Metro will seek to measure progress towards this vision through setting targets in the areas of:

- Employee Satisfaction Index (from the annual employee survey)
- Staff Retention (labour turnover percentage and stability indexes)
- Staff absenteeism
- Training (in terms of both the attitudes towards training in the employee survey, and the number of days training or briefing per employee in a year)

Human Resources Strategy

This has been divided into six areas of Human Resources activity:

- Recruitment
- To encourage talent to join the business and remain with it
- To raise the standard and calibre of staff recruited in order to provide the future skilled resources of the company.
- To use the internal resources of the company in a planned way, and always before looking externally.
- To make it easy to join the business.
- Organisation



- To create a culture focused on Team membership, and Development over hierarchy and promotion
- Service Culture - "nothing is too much trouble"
- Sales Culture - "I sold 10 units this week"
- To encourage a flat organisation, focused on measuring performance and achieving results.
- Training and Development
- To ensure that all employees have the skills and knowledge (feel competent) to do their current roles.
- To create an environment of self-learning and personal development.
- To create a small, high skilled group of managers who express leadership through a team based facilitation and communication skills.
- Reward Management
- To ensure that all employees have a long-term stake in the success of the business as a whole, and are motivated to be loyal, long serving employees.
- To reward and recognise both team and individual performance and skill acquisition as part of compensation.
- To pay and offer benefits which are at the median for the industry, and related industries, and ensure that all employees have a variable element to their pay.
- Communication
- To ensure that all employees feel well informed about the direction of the business so that they feel involved and a part of it.
- To ensure that all employees have access to the information they require to do their jobs, and can play an active part in the development of the business.
- To build the external image of Connex Mumbai Metro in how it approaches its people and people management.
- Employee Relations
- To act openly and honestly, and with respect for, the individual in all matters.
- To be seen as an Employer of Preference - "Best in Class".
- To work with employee representatives, and other stakeholders in order to develop partnerships.
- Administration and Processes
- To manage HR processes quickly and efficiently, as close to the business as possible.
- To automate processes where possible, and ensure security of people data.



- To provide relevant people and payroll data to management to allow optimisation of resources

19.19 General Team Organisation

A team organisation for executing the services is shown hereunder.

The proposed staff organisation will provide the required organisational, maintenance and scientific roles necessary to ensure Regulatory compliance standards and treatment performance guarantees are achieved.

The Metro will be operated with standards, systems and procedures promoting operational and maintenance best practices.

Health and Safety employee training and development policies appropriate to this contract will be implemented.

The organisational structure to operate the works will be based around multi-disciplined personnel and team flexibility.

Continuing development and instilling a sense of responsibility in all personnel is the key to building an effective staffing strategy. The transfer of skills and the development of a multi-skilled, self-governing and monitoring workforce is paramount to Connex's approach to long-term operations management.

All personnel will be expected to take responsibility and accountability for their work. This philosophy is actively encouraged by Connex and rewards self-initiative and commitment. This approach tends to promote greater job satisfaction and an improved working environment.

Personnel will be required to provide 24-hour cover in the CCR with other personnel being either present or on-call at home under a turning schedule.

The on-duty operator will act as the first-line response to alarm situations. The operator will call the Manager depending on the nature of the situation.



Organisation and Job Specifications

The qualifications and experience of the staff will comply with the Tender requirements objectives.

Connex Mumbai Metro will develop full operational guidelines, standards and policies in line with those developed for other Metros operations worldwide.

The staff roles and responsibilities are listed below. The qualifications and experience of the staff will comply with the Tender requirements.

Organisation Chart

As stated in the Mobilisation Plan, the Organisation Chart of the Company shall be as follows :

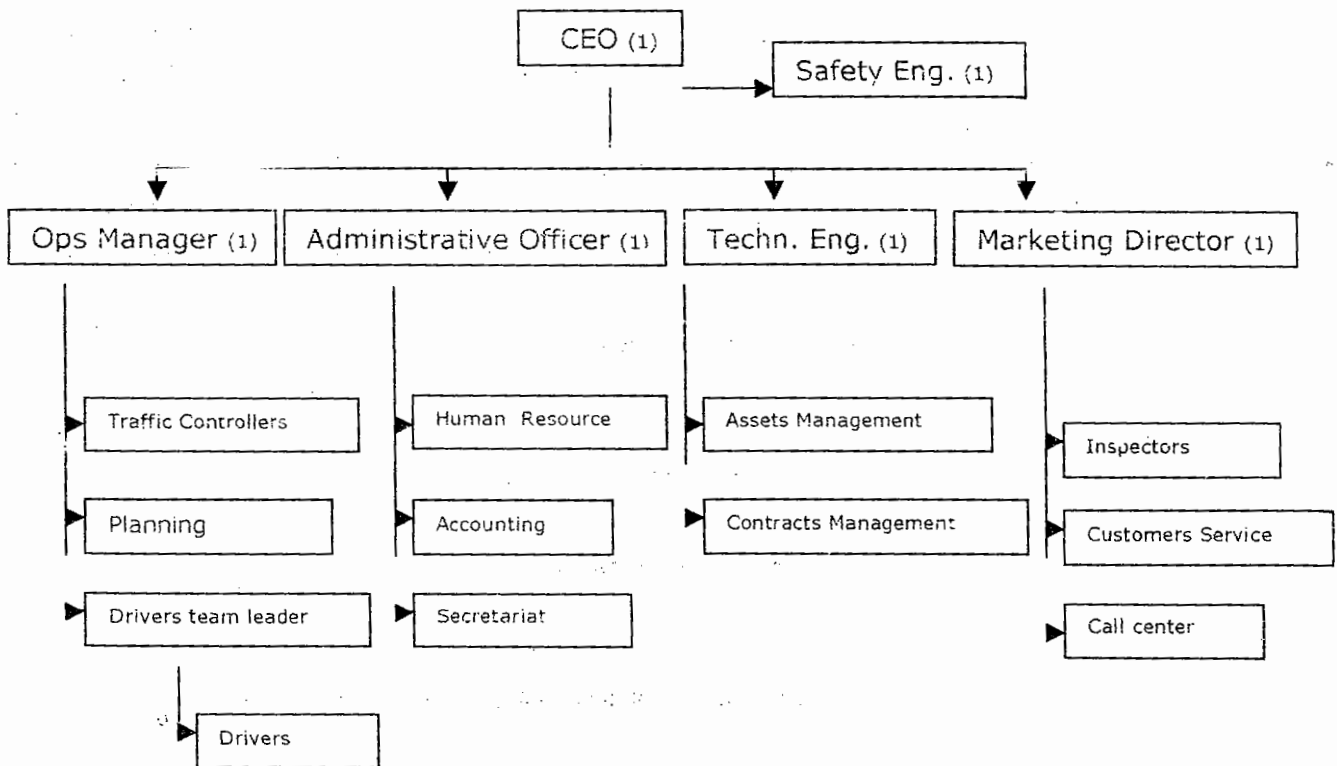

19.20 Managerial and Operating Staff Responsibilities

The respective duties and responsibilities of the members of the staff shall be as follows :

CEO

- Organise and manage the Company
- Keep adequate relations with the Client
- Report to Connex

Safety Engineer

- Organise safety in documents and training
- Analyse incidents and accidents
- Propose corrective actions
- Keep relation with fire brigade and police

Operations Manager

- Organise operations
- Provide quality service
- Check personnel qualifications
- Keep relations with local traffic authorities

Traffic controllers

- Follow operations
- React to perturbing events
- Report incidents

Planning

- Prepare operations
- Collect activity data

Drivers team leaders

- Follow drivers activity
- Report events
- Give directions to drivers
- Report equipment defects
- Assist controlling actions



Drivers

- Drive and follow time table
- Check vehicle and report incidents
- Sand and wash vehicle

Administrative officer

- Organise administrative activities
- Assess legal rules, statements and documentation
- Prepare financial reports

Human Resources

- Set up internal rules
- Assess social rules, statements and documentation
- Organise recruitment
- Negotiate with training sub-contractors
- Keep relations with Unions and personnel representatives

Accounting

- Record expenses
- issue invoices
- Follow capital needs

Secretariat

- Type reports and mail
- Keep record of documents
- Organise meetings
- Facilitate management organisation

Technical Engineer

- Keep relations with Suppliers and Contractors
- Check adequate level of maintenance
- Propose improvements
- Validate changes proposed by Maintenance Contractors



Assets Management

- Keep official list of assets
- Follow up list of assets
- Assess status

Contracts Management

- Keep data on Maintenance
- Check objectives and results
- Inform on incidents
- Keep record of incidents
- Prepare contractual actions vs. Maintenance Contractors

Marketing Director

- Prepare marketing and commercial plan
- Prepare communication plan
- Organise actions
- Follow up statistics
- Check passengers satisfaction
- Keep contacts with

inspectors

- Ticket controlling
- Equipment controlling
- Assistance to passengers

Customer service

- Ticket controlling
- TVM filling

Call Centre

- Telephone directing
- Passengers telephone assistance



19.21 Staff Regulations

Advertising, Recruitment and Selection

The Company will ensure that employees and applicants for employment are recruited and selected on objective criteria consistent with their skills, abilities and potential. No applicants or employees will be unfairly discriminated against on grounds of criteria not relevant to the performance of the job.

Training and Development

Connex encourages all its employees to participate in training and development programmes, and makes every effort to ensure that the selection criteria for training and development are not discriminatory. The results of the performance appraisal system will be reviewed annually by senior management.

Monitoring and Review

The senior management team will annually review and monitor the Organisation's progress towards human resources including staffing and training, and where necessary modify the policy and procedures.

Communication

The Company will monitor and review its Human Resources policies and procedures annually and undertake to communicate any changes in practice to employees. Positive action will be undertaken to ensure that employees are aware of the Company's policies and procedures.

Grievance and Disciplinary Procedures

Disciplinary Procedures will be clearly stated and in accordance to the general behaviour's rule book widely communicated in the Company.



Connex Mumbai Metro will ensure that employees who have experienced direct or indirect discrimination are represented and protected from victimisation. Any employee who feels that he or she has been treated unfairly or been discriminated against should follow the appropriate grievance procedure which will be set out in the Employee Handbook.

Employee Performance and Development

It is intended that consistent treatment is offered to all employees in all divisions and activities, and will take into account employment legislation and practices in India.

Employee Appraisal and Review

Performance Appraisal is a continuous process. Employees will annually have the opportunity for a more formal discussion with their managers about how they are performing in their job, to agree objectives and development needs for the next year and to discuss how they would like their career to develop in the future.

Employee Training and Development Programme

Connex is committed to the maintenance and improvement of the knowledge and skills of all its employees and encourages them to participate in the continuous updating and enhancement of their individual competencies, whilst recognising that this is a joint responsibility between the company and its employees.

In order to ensure compliance with this commitment, it is Connex's policy to:

- Aim to ensure that all its employees are offered encouragement and the opportunity to maintain and enhance their knowledge and skills where relevant to the needs of the Company.
- Identify and review the needs for continued training and development of each of its employees, and to make such training and development available when agreed.
- Monitor and review its training and development policy and practices at least once each year, and to set and monitor progress towards targets to improve its performance.



- Oversee and control training and development activities within Connex and to pursue the development and implementation of sound training methods and practices.

Connex will designate a Manager with responsibility for Human resource who will monitor the training policy, review the training needs of employees and function as the main contact between the Company and employees on training and development issues.

Employee Remuneration

It is Connex's policy to set overall remuneration and benefits at levels appropriate to the responsibility and performance of an employee whilst remaining competitive with relevant market rates.

An Employee is advised of remuneration in the letter of appointment. The employee will receive a pay slip detailing the gross to net salary and identifying all deductions.

The contract will be operated with standards, systems and procedures promoting operational and maintenance best practices necessary to comply with the final treatment processes. Health and Safety employee training and development policies appropriate to this contract will be implemented.

Staff Issues

It is anticipated that all staff will reside within appropriate travelling time to the work site.

19.22 Management of Employment and Industrial Relations

Interaction between Connex various bodies

Connex is a company that combines the advantages of a small-scale operation with the benefits of being part of a large group. The entire Connex Transportation group of companies acts as support for the operation of Mumbai Metro.



Connex often develops its operations in project format, with company-wide participation or parts of the company participating. Examples of this include disruption information, development of cleaning procedures, dealing with threats and violence, etc. By using the project format, we are able to maintain a smaller common administration and at the same time bring a very high level of knowledge to bear in the development work, with the participation of staff from the operational units. Development findings can also be implemented very quickly.

Across the various Connex companies, there are well-developed lines of communication (both formal and informal) at many different levels and of various types. In addition, the various units can serve as backup for one another.

Connex Knowledge Management (KM) - Best practices

For the purpose of achieving efficient use of resources and securing the undertaking, interchangeability of resources and know-how (Best Practices) is necessary between the various Connex units. A special world wide *Connex Knowledge Management Program* divided in the parts stated below handles this:

KM organisation involves all international regions and is structured into nine main topics. An international team with a process group with representatives of all international regions manages the process. Topic leaders and their international topic teams prioritise the items for exchange, handle the collection of data and exchanges of experiences. A support team handles with technical and administrative issues.

Country teams from Connex France, Connex AB, Connex UK and Connex GmbH identified KM contacts for collecting data and best practices

Dedicated tools as working international groups for each topic: quarterly meetings, Connex Intranet for database and catalogue of best practices, and tools. An international KM Newsletter for communication on new operational companies and list of best experiences



The different Knowledge Management groups are as follows:

1. Bus Fleet Management and Maintenance
2. Industrial Logistic
3. Market Analysis
4. Operation and planning
5. Quantitative Benchmarking
6. Rail Fleet Management
7. Train Maintenance
8. Services to Customer
9. Sourcing

19.23 Staff training and Development

Recruitment

Recruitment of both drivers and other personnel is a basic prerequisite for implementation of the agreed transport service. Connex is well aware that in India, and in the Mumbai area especially, there is an overheated labour market, which means that relatively long periods of long-term unemployment exist and there is the risk of a lack of manpower when it comes to qualified professionals. Our experience from other labour markets, for example in the UK and Sweden, shows that train drivers and other types of drivers in rail transport belong to a risk category when it comes to availability on the labour market.

The risk of a shortage of manpower makes it necessary to have extra foresight and planning when it comes to recruitment of personnel for Mumbai Metro. The time from advertising for personnel to the start of the driver's course, for example (the recruitment time) consists of, from experience, between two and three months. The recruitment period includes the advertising period, job interviews, aptitude testing and verification of medical suitability. Our judgement is that for train drivers in Mumbai, at least 4-5 months will be required from advertising for drivers until completion of driver training.



Basic training and in-service training

Basic training and in-service training are two corner stones in the training programmes for all staff training programmes. When it comes to Connex staff and the staff of relevant subcontractors performing safety-critical assignments (drivers, controllers, maintenance personnel and certain operational managers), special *basic training* plans will be produced, stating minimum times for the various sections of training. Training plans and in-service training plans will to a large extent be based on our experiences of Connex operation of the Metro and trains in Stockholm. The training plans will give certain fixed minimum service time spans for different safety-critical work tasks that must not be exceeded without repeat training being undertaken.

All staff (including relevant contractors' personnel) doing safety-critical work tasks will undergo regularly recurring *in-service training* in order to ensure that the required level of knowledge is kept up to date. Implementation of in-service training is suggested every two years. For the year in which in-service training does not take place, it is proposed instead that personnel carrying out safety-critical work tasks should undergo a knowledge examination that includes both practice and theory elements as well as sections on safety.

General training

Training is one of the most important ways of being able to influence attitudes. Attitudes are the building blocks for all stances towards quality and customer service. By investing heavily in the systematic training of our employees, Connex Mumbai Metro will be able to raise the quality of travel for its customers. A positive spin-off is that employees are happier, too.

Training plans

All staff whose work impacts safety will be trained in accordance with specially developed training plans, which will be detailed to RPA and the Railway Inspection Service well in advance of services commencing. This Appendix shows what training plans are required,



in our assessment and based on our experience, for the train service in Mumbai as per the present tender.

Training resources

Connex Mumbai Metro will rapidly be able to link in various tried and tested training resources from our train operations in Stockholm, and elsewhere, with the train service in Mumbai. This will guarantee initial training for test drivers, for example, and additional staff could quickly be drafted in for trial exercises. For the final training of drivers and other staff employed in ongoing operations in Mumbai, Connex envisages setting up a local Mumbai Metro training unit in Mumbai.

Fundamental personnel requirements

Staff competency and training are crucial in terms of the quality provided. Descriptions of our key categories, drivers and controllers, are reproduced below. The fundamental requirements for all categories of employees involved in train operations are:

- Approved training for the role in question.
- Fulfilment of medical requirements stipulated in regulations set by the authorities.
- Fulfilment of all requirements as to aptitude for the post.
- A strongly service-oriented approach and a good grasp of the requirements of working in the service industry.
- A good command of English, Hindi and Marathi
- A sound knowledge of vehicle theory, appropriate to the type of work in question.
- A good reputation and high stress tolerance.
- Accuracy and punctuality.

Control room staff

All quality in service operations begins with appropriate recruitment of staff in managerial positions. Careful recruitment is crucial to major aspects of the way the service is operated in years to come. Over a period of many years, Connex has developed a training programme for controllers and other traffic control personnel operating in various countries. Experience from training and developing the competency of traffic control staff



in Stockholm and Rouen will form the basis of the recruitment and training of controllers for the new train service in Mumbai.

Profile of requirements

Controllers, who are a key category for quality throughout the transport system, must fulfil the following profile of requirements:

- Approved training for the role of controller.
- Approved training for the role of train driver.
- Fulfilment of medical requirements stipulated in regulations set by the authorities.
- A strongly service-oriented approach and a good grasp of the requirements of working in the service industry.
- A good command of English, Hindi and Marathi
- A sound knowledge of trains and other technology.
- A good reputation and high stress tolerance.
- Accuracy and punctuality.

Training programme for controllers

Training to be a Mumbai Metro controller is contingent upon first having successfully completed the course leading to qualification as a train driver. The basic training to be a controller, which involves both theoretical and practical aspects, is tailored to the individual and takes about 30 days over and above the approximately 40 days' training required in order to qualify as a train driver. The course concludes with a test involving written, oral and practical examination elements.

The training programme to qualify as a controller goes into the training elements of the train driver course in greater depth on the one hand, and on the other, also includes special training elements relating to tasks that are specific to the work of a controller, including remote monitoring techniques and information systems as well as in-depth training in troubleshooting and fault handling in order to be able to function as the first line of technical assistance to the train drivers.



Because Connex Mumbai Metro controllers have completed their full training to qualify as train drivers, with additional, more detailed knowledge, the function of "technical assistance" is assured via vehicle radio during all service times, including in instances when the intervention of a controller at the site of the incident is not required. Mobile controllers and/or mobile technical vehicle staff are responsible for emergency line-side assistance throughout the service times.

Train drivers

Profile of requirements

All quality in service companies begins with good recruitment of service personnel. Recruitment determines major aspects of the implementation of the service for years to come. Drivers, who are a key category in the provision of transport service, must meet the following profile of requirements:

- Approved training for the role of train driver.
- Fulfilment of medical requirements stipulated in regulations set by the authorities.
- A strongly service-oriented approach and a good grasp of the requirements of working in the service industry.
- A good command of English, Hindi and Marathi
- A sound knowledge of trains and other technology.
- A good reputation and high stress tolerance
- Accuracy and punctuality.

Training programme for train drivers

The basic training for Mumbai Metro train drivers, which includes sections on both theory and practice, is individually tailored and is estimated to take 40 days based on our experience of training train drivers in Stockholm. We plan to train all drivers for lines A, B and C in order to ensure appropriate and flexible provision of staff. The course ends with written, oral and practical examination elements.

The training programme for train drivers is made up of a number of basic elements as summarised below:



Traffic technology

The employee learns the rules, regulations and instructions found in the Mumbai Metro Rule Book as well as the legislation outlined in various handbooks applicable to trains and public transport. In addition, the employee learns the practical skills required for driving trains.

Bearing in mind the special risks involved in driving trains in "mixed" traffic, extra emphasis is placed on driving in these conditions.

Vehicle knowledge

During this part, drivers learn how to operate the train and in addition, learn how to troubleshoot problems affecting the vehicle. The aim is for drivers themselves to be able to correct the majority of faults out on the line in order to minimise delays and other problems faced by customers. Examples of troubleshooting and dealing with vehicle faults are door faults, traction faults and towing faulty vehicles. Vehicle knowledge also includes, for example, basic electrical theory and the principles of replacing fuses.

Practical aspects and exercises

Training as a train driver consists largely of, in addition to theory, various practical exercises and practice sessions. The best way to remember something is to have it said to you, to read it and above all else, to perform the task yourself. Train driving is in many ways a practical "trade".

Service and quality

Service and quality form an important and integral part of the training to be a train driver. The objective of this aspect is that after completing the course, the employee should have the "right" customer values and practical skills in five key areas:



- Train stop announcements
- Disruption information
- Smooth driving
- Safe boarding and alighting
- Punctuality.

Inspectors and Customer Service Officers

Profile of requirements

The mobile Mumbai Metro staff (Inspectors and Customer Service Officers) will principally be recruited and trained in accordance with the same principles as Connex mobile staff on the Stockholm Metro. Great emphasis will be placed on personal aptitude and a high level of motivation for the relevant assignments. The profile of requirements includes among other things:

- Approved training for the role in question.
- Fulfilment of the mandatory medical requirements.
- A strongly service-oriented approach and a good grasp of the requirements of working in the service industry.
- A good command of English, Hindi and Marathi
- The required knowledge of vehicles and other relevant technology.
- A good reputation and high stress tolerance
- Accuracy and punctuality.

Assignments for mobile staff include the following:

Information

- Excellent knowledge of the Mumbai Metro fares system and network
- Knowledge of the Mumbai Metro organisation including the role of RPA.
- Knowledge of local geography and of one's own section of line and adjoining lines
- The ability to distribute timetables and other information to passengers
- Giving information about disruptions affecting train services
- Passing on information about disruptions received by pager
- Ensuring that current information is deployed in stations
- Providing general information about train services.



Order and security

- Alerting the emergency services as required - ambulance, police and fire brigade
- Familiarity with authority and procedures with reference to security work.

Ticket sales / securing revenue

- Ticket inspection on trains
- Inspection of ticket machines to ensure that they are working.

Vandalism / graffiti / cleaning

- Documenting, photographing and reporting damage and graffiti
- Where necessary, reporting damage and graffiti to the police
- In an emergency, if possible removing, repairing and replacing damaged equipment
- Carrying out straightforward spot cleaning in an emergency.

Training programme for mobile personnel

The basic training course for mobile personnel, which includes sections on both theory and practice, is individually tailored and takes approximately 20 days. The course culminates in an examination, taking the form of a final written and oral test.

In-service training for all staff

The purpose of in-service training is to keep staff up-to-date with the skills and knowledge that are not used every day, but are nevertheless important when needed. For example, ongoing information to our customers in the event of any disruption to operations, as well as handling various types of irregularities in the provision of transport services, including those occurring under very stressful conditions.

At present, in connection with ongoing safety examinations for drivers and controllers, there is an in-service training module with an emphasis on quality and safety. The course includes reinforcement of vehicle knowledge as well as the reason for good treatment of customers by all categories of staff that the passengers may come across while travelling.



Training with regard to disruption information is intended to give all staff the motivation and knowledge required in order to be able to give "their" passengers information in a positive way if the service does not go as expected.

In-service training of the mobile field personnel will be partly co-ordinated with in-service training of drivers and controllers in order to promote reciprocal exchange of knowledge between categories of staff.

19.24 Rule Book

All types of different rail operations (Metro, Train and Railway) need for safe and secure operation a special Rule Book containing at least general rules, safety and health rules, vehicle operating rules, rules for maintenance, training and update briefing and adherence monitoring.

Connex have experience from different countries of making up such types of Rule Books. For normal railway operation the main Rule Book often is provided by the "Railtrack" (infrastructure management) company, but for Metros and trainways the Rule Book often is a product of the Operations Company.

For the preparation and application of the Rule Book for Mumbai Metro, Connex will use its experience from especially Rouen and Stockholm. In Stockholm Connex work under five different Rule Books (one for the Metro, two for the Metro and two for the Commuter Railways). The Rule Books in Stockholm are under the formal responsibility of the Public Transport Authority (PTA) but Connex Stockholm through its Safety Department has taken a big part in the preparation and up-date of the different Rule Books.

In the preparation of the Rule Book for Mumbai Metro Metro Connex Mumbai Metro will use its safety experience and resources from Connex UK, Stockholm and Rouen.

The Rule Book is a component of the proposed Safety Management System. The Safety Manager of Connex Mumbai Metro, directly reporting to the Managing Director, will have the full responsibility for the Mumbai Metro Rule Book.



The Safety Management System is made up of the following components:

- Policy,
- Organising
- Planning and Implementing
- Measuring Performance
- Reviewing Performance.

General Rules

The whole process is subject to internal management check and external audit.

The Rule Book will cover the following general rules which include :

- Glossary of terms and abbreviations
- Individual conduct
- Personal safety
- Security of premises
- Communication
- Rules for training and medical (health) examinations
- Supervision of skills, knowledge, medical demands and training
- Reporting of accidents
- Calling the emergency services
- Dealing with fallen down overhead wires
- Dealing with accidents and fatalities
- Dealing with fires and fire prevention

Safety Rules

Safety rules (other than VEHICLE) shall include:

- Intervention on the line
- Electrical rules, intervention on power supply equipment
- Actions in case of Fire
- Actions in case of accidents



- Working with maintenance on infrastructure
- Working with maintenance close to the Metro
- Working as a controller in the Control Rooms
- Working in degraded situations.
- Respect of procedures

Vehicle Operating Rules

Safety & VEHICLE Rules which include :

- Preparation driving of vehicles
- Entrance into and departure from depot
- Driving vehicles in the depots
- Distances to respect, e.g. switches
- Working on vehicles (maintenance)
- Driving vehicles under normal conditions
- Driving vehicles under abnormal conditions
- Driving vehicles on the line off-street
- Driving vehicles on the line on-street
- Drivers action at accidents, fires and fatalities

19.25 Training and Update Briefing

On appointment to a job covered by the Rule Book a Training Needs Analysis of the individual will be undertaken. They will receive training appropriate to their individual requirements. Rules updates and reminders (the later for example following incidents) will be briefed through a number of media, including: notices and publications, face to face individual briefings, team meetings, news letters and Intranet.

19.26 Adherence Monitoring

The Adherence monitoring will be achieved through 'management by walking about', formal management checks and audits conducted by both external and internal auditors.



Internal control and management of Connex Mumbai Metro operations is effected by means of contracts of employment between the managing director and reporting managers. The contract governs, in addition to responsibility for health & safety at work, responsibility for quality and quantity of production as well as responsibility for human resources.

Monitoring of drivers carried out internally is to ensure that safety and quality of the service will rest on four pillars:

- Basic training
- In-service training
- Help and support
- Monitoring and follow-up

In-service training chiefly takes place in conjunction with regular examinations on safety regulations, and focuses on safety, quality of service and vehicle knowledge.

Help and support will be available in the course of day-to-day operations. Personnel including instructors and supervisors, sitting in with the drivers as they work, observing them and conversing with them, provide this. Ongoing monitoring and follow-up is also carried out in the same way.

System audits

System audits are designed to ensure that everything affecting a particular area is charted and documented. Our service structure for a certain quality area is made apparent in this way. Hence it is possible to find weaknesses and get to grips with the causes of faults. The opportunity to discuss the details of the quality area from a strategic perspective is one of the most significant aspects of this. So far, Connex in Stockholm, for example, has carried out system audits relating to disruption information and the dissemination of safety information.

19.27 Protocols for Third Parties

Interaction with the outside world



Connex Mumbai Metro intends to set up tried and tested channels of communication and working partnerships with RPA and with ancillary bodies such as the police and emergency services, as well as with other relevant organisations. This will ensure that the train service operates at a high level of safety and a consistently high level of quality. There will be ongoing co-operation with the organisations listed below as well as with others:

- RPA
- VEHICLE maintenance department
- Infrastructure maintenance department
- Ticket machine maintenance department
- Police
- Fire brigade
- Ambulance service
- Relevant Road & Traffic Authorities
- Other transport operators (with regard to disruption information, alternative transport, etc.)
- Event organisers
- Schools and social services for the purpose of preventing injury and violence
- Supervisory authorities (such as the Railway Inspection etc.)
- Press and media

All relationships must be characterised by professionalism and a business-like approach as well as aspiring to contribute to the overall perspective of providing safe and reliable operation of public transport in and around Mumbai.

19.28 Transition periods / Handover to the Client

General

On completion of the Operation Period of the Works, Connex Mumbai Metro will hand over the Works to the Employer.



The works will be handed over following satisfactory conclusion of Tests After Completion to be detailed in due time.

The staff, except for the CEO, shall be taken over by the Client.

Immediately prior to completion of the Operation Period, Connex Mumbai Metro will carry out final repairs, repainting as necessary and make good any defects, if they are beyond normal wear and tear.

End of Operation Period Report

At the end of the Operation Period, Connex Mumbai Metro will provide a report containing a statement regarding the overall operational performance. This report will include information concerning the condition of the equipment, schedules of spares on the Site, outstanding repair orders together with a list of all documentation and information necessary for the operation of the Works.

Handing Over of the System to the Client

After completion of the Operation Period, Connex Mumbai Metro will transfer the whole of the System and staff (less CEO) to the Client.

Prior to the end of the Operation Period, the Client will carry out an inspection with Connex Mumbai Metro to identify any defects or damage which have occurred during the Operation Period. These will be rectified prior to the expiry of the Operation Period. All up-to-date Documentation including Operation Manuals will be submitted to the Client for approval. Connex Mumbai Metro will also submit complete Health and Safety Documentation, including the Safety File.

Take-over and Transition Plan

A well-planned and smooth phased take-over and transition of the services to the Client's control will retain the confidence of all staff, regulatory bodies and the general public. The planning process is important to avoid confusion and disruption that can occur if major change is carried out too quickly.



The Plan will ensure that complete take-over will occur in a logical and general fashion.

Connex has considerable experience in the management and transition of operations.

The key to a successful transition is to be flexible and adaptable and to be prepared to modify plans to cope with changing circumstances. Communication and information dissemination is important to ensure all employees are aware of what is happening at all times.

The Plan will incorporate the overall Business Plan Objectives into functional areas such as general management, operational aspects, financial and administration. For each area, a transition program will be developed. The main elements in developing the transition tasks are to focus on the issues such as timeframe, facilities, operational assets, ongoing work, etc.

Connex believes that its personnel will be able to offer skills and experience to the Client that will be invaluable. Consequently, considerable attention will be given to understanding and explaining the philosophy and the policies that will be adopted by the Client.

The Client will require a new CEO to be trained by Connex and meetings will be arranged to enable senior management to explain Connex's philosophy regarding best industry practice in relation to utility management and human resources management.

19.29 Marketing Policy

Marketing policy guidelines

For the Operator and Concessionaire, a strong, creative, informed, and results-oriented marketing initiatives are indispensable elements of a healthy transport program. Therefore, included in this proposal is a series of :

- analyses and actions designed to understand who the metro customer is, what he or she needs, and what it will take to attract others who do not ride the service.
- actions to improve the reality and the perception of the service, and ensure that the transport offer is as attractive as possible.



The main actions that we will introduce are the following :

<p>Market Research</p>	<p>Yearly customer satisfaction survey.</p> <p>Every 3 years, ad hoc research studies (origin – destination surveys, qualitative surveys including focus groups).</p>
<p>Customer Information</p>	<p>Definition of design guidelines.</p> <p>Information outside and inside stops : in each stop, general network map and a route plan, map of the surrounding area, timetable posters, fare information, information about the smart card and on selling points.</p> <p>Information onboard trains : in each unit, route plan, posters to provide information about the Metro and Mumbai city life.</p> <p>Information on paper : network map with connecting points to buses, pocket guide including the fares structure, selling points, frequencies in peak and off-peak times, etc. Yearly update.</p> <p>Internet site : includes network information (routes, timetables, maps, optional trip planner), city information and a customer Contact section.</p> <p>Call center : Customer care and Information phone service including a call protocol and a follow-up protocol for complaints and feed-back.</p>
<p>Sales and Distribution</p>	<p>Flexible ticket options according to customer needs with a focus on price incentives and combined tickets.</p> <p>Ticket design to project a higher quality image to passengers and raise extra revenue.</p> <p>Direct sales point at a commercial agency located in the city heart covering : information, loading and reloading of smart cards, ticket sales, payment of fines and lost property.</p>



Communication and promotion	<p>Definition and design of a brand for the Metro system that will be associated with values.</p> <p>Communication prior to commercial start : presentation of the main milestones of the project, information and promotion meetings</p> <p>Communication at launch : Information and assistance to passengers in the stops and inside the vehicles.</p> <p>Passenger's charter : outlines key statements that are the foundation of our commitment to passengers.</p> <p>Internal communication : quarterly newsletter.</p>
Customer Service Management	<p>Customer service training : development of a customer oriented culture through information and training sessions, and active involvement in local promotions.</p> <p>Customer service quality program : monitoring of passenger satisfaction, daily and monthly reports, tailored action plans to improve the service.</p>

Marketing objectives

No transport operator can be truly successful without a thorough understanding of who its customers are and what they want, followed by the redesign of the network services to meet that demand. By clearly understanding the needs of the market (people and local conditions), the Operator will deliver the best possible service to customers, present and future.

Transport networks need to attract an increasing number of passengers by providing the most frequent, comfortable and efficient service possible. Our overall marketing objective is to design and deliver a product that can grow and evolve to meet and exceed customer expectations and the changing demands of the transport market.

Over time the Mumbai Metro system will be considered to be an integral part of Mumbai life and a realistic alternative to the car for work, school, service and leisure activities.

Under this general umbrella, specific marketing objectives will be devised. Based on our experience, here are some examples :



- Ensure an excellent image and perception of services and staff leading to a growth in patronage
- Contribute to the growth of market share in all segments through specifically designed programs and initiatives and services to meet customer values
- Encourage use of the service outside peak hours
- Ensure loyalty from customers and increase frequency of use
- Protect and improve the integration and multi-modality of transport services
- Enhance the role of the network in Mumbai's city life by creating partnerships with key organizations, event and industry bodies.

The Operator will confirm and validate these points before the commercial launch and during the operation period.

Key target groups

Analysis of target groups' travel experience, critical to developing and marketing attractive differentiated offers, shows that reliability, frequency, and speed are passengers' key requirements. The Operator will develop customised messages and use appropriate and innovative media to communicate these requirements and grow metro travel in each segment.

For the purposes of this analysis, passengers have been segmented in five customer groups. There are additional smaller segments; those listed below comprise a suitable segmentation of the market for the launch period. The Operator will revisit this analysis regularly as passenger habits and attitudes change.

Segment	Summary description
Regular peak hour commuter	Five days a week, every week
Semi-regular peak hour commuter	Two or three days a week, every week or five days a week, but not every week
Off-peak regular	Students, shift workers, part-time workers
Off-peak occasional	Shoppers, appointments
Off-peak exceptional	Tourists, special events

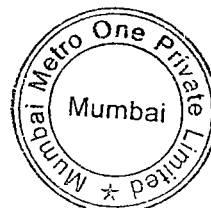

We have developed and analysed a typical travel scenario for each segment, comprising what passengers think and feel as they prepare for their trip, move through the various stages of their journey, and complete their journey. Based on the results, we identified the groups' detailed travel expectations, needs, and desires. We then prioritised the results for each segment, as the basis for devising the messages that ensure our service is the most attractive to these groups.

CUSTOMER SEGMENTATION & MESSAGES	Peak commuter	Semi-regular commuter	Off-peak regular	Off-peak occasional	Off-peak exceptional
SUMMARY DESCRIPTION	5 days/ wk every week	2 or 3 days/wk OR 5 days/ wk not every week	Students, shift & part-time workers	Shoppers, appointments	Tourists, Special events
EXPERIENCE REQUIRED	Reliable Frequent Fast	Reliable Frequent Fast	Reliable Frequent Value For Money	Reliable Easy How to use ?	How to use Easy Reliable
TYPE OF MESSAGE	Convince + Keep loyal	Convince + Encourage to use more	Convince + Keep loyal	Inform, Attract with partners	Inform through partners

Built into this segmentation model is a measure of loyalty including whether customers are loyal by choice or through dependency. In the case of potential customers, it involves identifying those with a predisposition to use the metro as opposed to those who cannot or will not.



19.30 Customer information

Information is the entry point to any service. Without adequate information on a service, people generally refuse to use it. On the contrary, when people know how to use the service, it turns into a pleasant, hassle-free experience.

Potential customers must be considered as well as existing customers. Sometimes we rely on the fact that the regular rider knows what vehicle to take, where to stand, and how to pay a fare. The regular rider simply doesn't need as much information. However, the newcomer needs adequate and easily accessible information at any given time and under changing circumstances.

This new Metro system will be first and foremost a commuter service in peak hours. This multi purpose service will cover the travel needs of shoppers, religious people, visitors and tourists. Gaining customers during off-peak is a major goal. This implies providing information over and above what might be considered to be strictly "essential".

The Operator will provide assistance with all necessary documents to help passengers prepare for their trips. Given the various communities, information will be printed in following languages: English, Hindi and Marathi. Documents specific to the tourist market will also have text in the major foreign languages.

The following suggestions will be part of the information package, and take into account the needs of both the regular and of the potential or infrequent customer. The result of the proposed plan will :

- Guarantee the overall level of passenger satisfaction,
- Enable the metro system to be better integrated into city life,
- Increase patronage by infrequent off-peak users, especially tourists.



Information in stations

The Operator propose the following:

- A general network map with connecting points, links to other transport services of the city and suburbs, landmarks and sights (in addition to information such as parking areas, wheelchair access, etc.) will be affixed to the wall.
- A route plan will highlight the routes and show clearly all stops served by the metro leaving from each platform. It must be positioned intelligently, i.e. at the point where the customer must decide whether to go left or right. Signage to and on platforms will be adequate and easy readable.
- Large timetable posters in each stop with specific departure times or frequencies at peak hours.
- Basic fare information (prices of all ticket available on automatic vending machines) located next to the ticket vending machine. A potential customer who has never been on the Metro system before will want to have a rough idea of fare prices before he gets down to calculating the price of his particular trip.
- Clear information to explain to potential customers how to get a smart card, how it works and what are its benefits, where to load and reload it on the spot and elsewhere.
- Loudspeakers and dynamic panels will also be used to inform passengers of any disruptions to the service. The real-time information displayed will include at least : the line number, the destination of the next vehicle, the number of minutes before the arrival (or departure) of the next metro and information when there is some change regarding the operation of the Metro system. Information will be displayed in three languages: English, Hindi and Marathi.
- Information at the arrival stop, especially for visitors and tourists, the customer, leaving the metro stop, will need to know where precisely he is and in which direction he should head. At each stop, we shall therefore need :
 - Platform signs with the name of the stop that are clearly visible from anywhere inside the metro vehicle,
 - A map of the surrounding area,
 - Direction panels to all major landmarks or places of interest, public transport connections and park and ride facilities.

Information in vehicles

The Operator will make the service user-friendly, particularly for irregular users. Passengers should be able to follow stop by stop where they are and know where they have to get off. They will feel reassured to see on-board the Metro vehicle :

- the name of the terminal stop on the exterior front panel. This information will be set automatically.
- a route plan in each carriage to check how many more stops there are before his destination. Ideally the route plan will be displayed above the doors.
- dynamic visual information through the form of illuminated panels that indicate the name of the current stop, the name of the next stop when the vehicle doors are closed, and the terminus when doors are open. The Operator will also be able to send specific messages.
- audio information, during normal operation, the system will automatically announce the next stop name upon approach of the stop. The driver and / or the customer relation staff will be able to send complementary messages regarding security or regarding the safety or the operation of the vehicle.

Other information material

Information on paper

The Operator will produce a series of paper documents to ensure that passengers have handy information packs adapted to their requirements. As in all our networks we apply strict rules on the preparation of these documents to ensure that they provide the information required by passengers in the best possible format.

The following will be part of the information package available on paper :

- Network map with connecting points to the buses,
- Pocket guide including the fares structure, methods of purchasing a ticket, information about the smart card, and background information on the metro. The pocket guide will include the Metro timetable presented in the form of frequencies in peak and off-peak times.
- Remote information, internet site and call center



Internet site

As the passenger's requirements change over time, it is extremely important for a provider of public transport to keep the service up to date. Passengers expect all service industries to use the latest technology available. We believe that urban transport networks should not be excluded. Following studies, we have noted that the demand for Internet booking and information is a very fast growing sector. To offer the maximum to our passengers, the Operator will install a Internet site for the metro network in Mumbai, that will be on line at least 2 months before the operating launch.

The Operator has experience in the preparation and the setting up of internet sites that can be easily managed by the network to ensure that the site can be updated within minutes and without having to pass by any third party.

There are three main sections. The first contains information about the network (routes, timetables, maps, a optional trip planner). The second contains everyday information where the reader can find information about the city (points of interest, events, otehrs). The third part is a customer contact section (linked to the call center).

Call center

The Operator will put into a place a call center that will be recognized by passengers as a customer care and information phone service. A team of 5 employees will handle calls throughout the metro days of operation.

The aim of each call will be to listen to the customer, not to convince him that the Metro system and every member of its staff are perfect. A call protocol will be introduced in order to provide the best customer service to customers. Call centre staff will be encouraged to admit errors in the service provided.



The Operator expect that the type of questions answered will be the following : times of departures, fares, how to use the service, problems encountered by the passengers, lost property, background information on the Metro system.

The call centre staff will use the internet site as their source of information to ensure that the same answer is always given to the same question. The phone number of the call center service will figure prominently on the Internet site to ensure that passengers know where to call in case they cannot find the information they want on the Internet.

Customer Relation Agents on the network will be encouraged to use the customer care and information phone service if they cannot answer a passenger's question.

The call center service will be available for the longest period of the day possible. The Operator will need to analyse the travelling habits of Mumbai residents further to decide on the precise hours of operation but we would expect to open the lines daily from approximately 6am until 8pm. A large part of the information on the network that is available will be accessible on the Internet site 24 hours a day.

A single phone number will be communicated to customers. Calls will be handled through key pad activated menus to choose for example the language, the subject, etc. The agents will be able to speak to the customers in English, Hindi and Marathi.

The Operator can expect the high quality service of the call centre to generate excellent word-of-mouth promotion for the network. A level of satisfaction that cannot be generated by any advertising campaign will pay the investment of additional time spent on each call back.

19.31 Customer service

A focus will be made on the development of a customer oriented culture. The attitude of employees to the customers, and their ability to understand their travel needs will be a critical factor in making the service truly accessible.



A dedicated "customer service" will be introduced to meet potential and existing customers' expectations. The Operator will appoint one person as "Customer Service Manager" to guarantee the level of service offered to passengers. Fundamental to the success of the marketing strategy is the ability of staff to welcome the customer and provide courteous, helpful service.

Successfully motivating staff to embrace high standards of customer service, and to accept their responsibility and the role they play in promoting the organisation, involves substantial efforts in terms of attitude and the overall culture of the company. Our commitment to customer service is illustrated in our approach to training, which results in high professional standards throughout Connex organisations. Our Institutes of Urban Environment in France, UK and Australia are specialised training centres operated jointly by Connex and local authorities.

As so many of our customers equate service with people, it is also important to establish a higher profile for all staff, particularly the customer relation staff. Service staff will be mobile, and actively involved in local promotions and information sessions, giving them the opportunity to interface with and assist customers. They will wear visible uniforms so that passengers can clearly identify them and their role will be clearly identified to all as providing information and assistance to customers during their journey.

Based on the particularities of the network, the staff and passengers expectations, the Operator will devise a customer service manual to explain to staff how to provide a friendly and efficient service. Gestures, attitudes, and key actions are some of the points we aim to pass on to our staff at our training sessions.



19.32 Branding and trademark

The introduction of the Mumbai Metro system will be a major event in the history of the city. It is important that the Metro system be seen as modern and dynamic and that its image reflects the values of the communities that it serves and the level of service that both residents and passengers expect. It is essential that Mumbai has a positive feeling concerning the Metro. If the Operator are to make the Metro system an integral part of the city it must have a personality or an image that people can identify with and recognize. The brand will be seen and become known by the residents of Mumbai through advertising prior to launch, through the vehicle livery, through the uniforms of the personnel and through all customer communications. Everything that represents the Mumbai Metro will have a similar look and feel. Passengers and residents will become more and more familiar with it. The vehicles will help reflect the modern image of the system using the latest technology and bringing new levels of travelling comfort. Personnel will represent the high levels of customer service that the Operator will bring. Passenger information documentation through its clear and simple design will reflect the expertise and professionalism of the operator. The Operator will associate a complete program of internal and external communication concerning the values that we wish to associate with the brand.

19.33 Communication prior to commercial operation

The heavy works that will be undertaken in the city to build the Metro system will affect the everyday life of Mumbai inhabitants and public transport riders; roadworks will be in progress until launch day, some of the of bus routes will be changed for a period of time, and traffic congestion will increase.

It is important not to miss the communication before start-up and to reassure the community of the benefits of the metro system : The Operator will put into place the following actions :

- Explain the project and give the main milestones of the project until launch. A model of the Metro system and its itinerary could be shown in different places along the route wherever possible. This action shall be well coordinated with the transport authority.

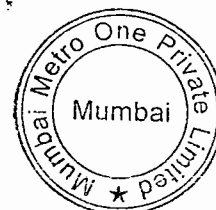

- Organize information and promotion meetings to explain in simple terms what the new network will bring in terms of concrete advantages, and answer queries. Some of our customer relations staff will take part in local promotions and information sessions to interface with potential customers.
- This action is essential as the Operator will get a direct feedback from the perception of local citizens and expectations of potential passengers, which will give us keys to devise the communication strategy.
- Communicate on work in progress on a regular basis. Special press events could be organized to release information and photographs to journalists : for instance the first stop, the first vehicle, etc.
- Start to inform our potential passengers of the new service. This will start to be done two months before launch through the metro Internet site and Information phone service.

19.34 Communication at launch of commercial operation

Timing and credibility are key as expectations are high. Our communication strategy will focus on information and assistance of passengers, while the Concessionaire on definition of the central messages of media strategy and organization of public relation activities. This launch communication will try to build on the pride that Mumbai inhabitants and visitors will feel in using a new, modern Metro service.

19.35 Information and assistance to customers in the stops

Our customer relation agents handle several tasks onboard the metro: they inform customers, help to prevent fare evasion and vandalism and safety, and control the level of cleanliness. During the commercial start the Operator will focus their role on information and assistance to passengers.



Extra staff will strengthen our numbers during the first weeks of operation. They will keep a close watch to public transport newcomers and people with difficulties. Our marketing and commercial management team will be split in the main stops to coordinate them and give a hand during launch.

The Operator will put a great emphasis on the training of staff, that we consider to be the shop window of the service. They will be trained to quickly understand people queries in order to provide an efficient, helpful and friendly service from the first day of operation.

Service staff will wear visible uniforms and badges so that passengers can clearly identify them. To inform and motivate our staff, the Operator will present to them the actions and timing of the communication campaign in advance of its implementation.

This will also show our customers during launch that the level of information of our staff is consistent.

19.36 Define our communication claims

Approximately one year before the commercial start the Operator will assist the Concessionaire to develop the precise commercial launch strategy.

Communications will focus on the arrival of a new era of transport for Mumbai and a high level of customer service, as we consider that reliability, frequency, ticketing and overall information are basics that will be right beforehand.

The Operator will put also the emphasis on the way to use the service and the benefits it will provide to customers. The objective from start on will also be to create a new image that will benefit the broader community.

Set up public relation activities

Public relation activities will be organized by the Concessionaire to generate positive press coverage, and the Operator will assist the Concessionaire whenever necessary.



A Press launch day will be organized approximately one week before launch and a similar event for local VIPs. All media will be invited among which national television and radio channels.

Media relations

The Metro operator has had a wealth of experience with the media both as a corporate company and a transport operator. A real partnership will be built with the local press to develop a long term relationship with Mumbai residents.

After launch, public relation activities will continue on a daily basis in the form of regular updates and frequent press releases particularly during the first months of operation. The information provided to journalists will deal or example with the growing number of passengers and the achievement of reliability targets or will detail the positive effect of road traffic in the area covered by the metro.

To ensure that information is readily available, a "News" section on the Internet site will list the most recent releases and provide an archive for journalists to browse. This will be a free-access section so that passengers can also read press releases.

Our Customer Service Manager will be our Press Officer. He will be the day-to-day contact for journalists with a press desk manned at all times. Our strategy is to push news to journalists and to provide honest and factual information.

In the case of an exceptional event the Operator will have procedures to react in order to reduce the impact of any major incident on the image of the network. The Operator will have a reduced hierarchical chain and co-ordination with the network through regular contact with Connex headquarters. Our Marketing and Sales Manager will be the company spokesman.

In the case of an emergency the Operator will call an immediate press conference led by the local manager in charge of the Connex communication. The principle of our communication is factual and objective, with no speculation.



19.37 On-going communication and promotion

Many of the tools prepared for launch will be used in the first three months of service. Thereon they will be adapted to take account of the fact that we are now dealing with more and more current passengers, less potential customers and a generally higher level of awareness of the network.

The internet site will be modified to promote on-going activities. The customer care and information phone service will take on its role as a customer contact service dealing with all communications with passengers.

The propositions below are based on real-life initiatives that the Operator has brought to existing customers all over the world. These few examples are meant to illustrate the type of creativity and initiative we bring to any project. The Operator believe that the actions below will help us to attract new customers and encourage the loyalty of existing customers.

19.38 Customer relationship

In the first year, relationships will be established with our clients to ensure the best possible "feel-good" factor associated with the network, good word-of-mouth promotion and of course to increase both income and frequency of use.

Once the customers become regular riders, a key communication tool is relationship marketing : regular passengers will know that we appreciate their loyalty and we will encourage semi-regulars to use our services more by providing them value-added benefits. The inception of the smart card will provide the necessary tools to offer a customer relationship program in which customers can enroll.

Discount travel is offered with bulk purchase. The Operator will team up with some of Mumbai's leading companies to bring passengers exclusive discounts offers through the program on shopping, restaurants and entertainment.



An essential issue for the concept to be successful is communication and promotion. Posters will be displayed at all stops, and if necessary a direct mail campaign may be undertaken through a mailing list purchased covering for example companies close to the metro route.

From a passenger's point of view the Operator can clearly demonstrate that we are keeping them better informed and that there is a real advantage in communicating detailed personal information to us. If successful, these passengers would start to understand the real value of relationship marketing programs.

19.39 **Market research program**

The Operator will undertake extensive quantitative and qualitative research to refine marketing strategies. There will be an on-going program of focus groups and community forums with specific market segments including non-users. The Operator considers that this process is a good way to encourage innovation and deliver a better quality of service.

The focus group discussion will focus on participants' perceptions of an ideal metro service and identification of service characteristics that would influence their decisions to use the service, or to use more frequently.

These data would be analyzed and also compared to the data of existing ridership and performance standards. A series of recommendations will be developed to encourage service use by non-users, attract new riders, increase ridership, and engender customer loyalty.

Maintenance Plan

19.40 **Introduction**

The primary function for the maintenance of the system is to ensure a safe and reliable operation and function of all systems of the Metro system. For all subsystem an appropriate maintenance plan and schedule will be designed and implemented. The mayor subsystems are:



- Electric Multiple Unit
- Ticket Vending Machines
- Track
- Substations and Overhead Catenary System (OCS),
- Control Systems (SCADA, train on-board systems, etc.)
- Signalling
- Communication System (radio, passenger announcement, telephone, etc.)
- Station and Station systems (includes escalators, lifts, lighting, etc.)
- General Infrastructure:
- Depots and other Structures,
- Security systems (CCTV, fencing, emergency phones),
- Electrical distribution,

Utilising the experience and knowledge that Connex has acquired over many years managing maintenance activities, Connex has prepared an approach to the Maintenance which will benefit the passengers, MMRDA, our consortium and us as Operator.

During the Development Period each individual plan shall be consolidated in the System Maintenance Plan, which shall be used to manage the maintenance requirements for the system, taking into account the necessary preventive maintenance necessary to ensure the highest possible availability of the subsystems relevant for the operation of Mumbai Metro One. For each subsystem a detailed maintenance plan shall be developed and implemented.

During the realisation of the project it will be decided which tasks shall be executed by the own staff or which shall be outsourced. These decisions will be taken according to the technical and operational feasibility of the envisaged tasks by contracting experienced firms for the maintenance of certain subsystems.



19.41 Maintenance Philosophy

To ensure an efficient operation the approach to maintenance shall be pro-active with the purpose to guarantee during the whole contract's period in every moment a safe and reliable operation of the system including – amongst others – also the following services:

1. Responsibility for the maintenance of all systems of the Metro system
2. Preventive maintenance of all systems as foreseen in the producer's technical handbook
3. Corrective maintenance of the systems including troubleshooting and failure elimination, repair/exchange or substitution of faulty components and replacements.
4. Prescribed overhaul of the EMUs and other systems during the contract's period of 30 years and the foreseen overhaul works.
5. 24-hour a day and 7-days a week phone hotline for assistance of train drivers and operational management in case of technical trouble during operation.
6. Set-up and updating of the maintenance history of all systems.
7. Certification of the maintenance organisation according to ISO 9001 within one year from beginning of the activity as well the necessary successive audits during the train operation contract's period.
8. Periodical inspections of the systems and especially of the vehicles following the indications of the authorities and the manufacturer.
9. Engineering-support from the manufacturers.
10. Continuous updating of the maintenance documentation.
11. Continuous training of the maintenance staff.
12. Operation and up keeping of the maintenance workshop and its equipment.

All maintenance activities detailed in the System Maintenance Plan will be performed to ensure its compliance with the Indian legislation.

The extensive experience of Connex in direct maintenance management and contract maintenance management places us well to overcome any problems in the maintenance area, of these arise in the future.



19.42 Maintenance strategy

The implementation of a System Maintenance Plan underpins our approach to this responsibility and will ensure all maintenance is performed to the levels required especially for the vehicles and infrastructure.

The primary strategy to be used is Preventative Maintenance. By establishing and following a program of inspection and replacement (before failure) most disruptions to the System will be avoided. For each subsystems detailed records for all maintenance activities will be kept and monitored.

The maintenance plans for each subsystem will be periodically reviewed and discussed with the manufacturer if necessary.

The Maintenance Strategy will be managed by the Technical Engineer during the Development Period. The Technical Engineer will have the resources and appropriate skills to ensure the successful performance of the System Maintenance Plan. During the Development Period and Operation additional resources will be provided from Connex's operations worldwide as required.

19.43 Safety

Safety is very important to Connex. All relevant safety parameters and performances will be checked and verified by the Safety Engineer. The Safety Engineer shall ensure the safety of the System and satisfy the requirements of the System's Safety Case. In detail these responsibilities include:

- The approval and acceptance of assets and systems into service, most notably during the mobilisation period;
- Assisting in the integration and configuration control for all the assets of the System;
- Proper maintenance of the assets of the System;
- Maintenance of the safety assurances, accreditation and documentation associated with the assets of the System;

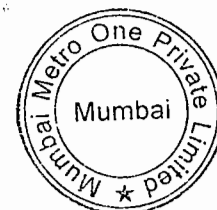

- The specification of competency requirements of staff and contractors to work on the safety critical assets of the System and the development of associated licensing and training programmes.

It is essential to the safety of the System that suitably trained and qualified personnel continue to be employed in the maintenance of safety critical assets. To this aim the following actions will be taken:

- In order to ensure that only suitably qualified and experienced staff are employed in the maintenance of the assets of the System, we shall ensure that all maintenance staff will receive appropriate training. The training will be based upon a training matrix which details each of the competencies required of a Technician when undertaking safety critical works as recommended by the equipment manufacturers. This will be allied to a scheme of annual re-evaluation of staff competencies and a programme of quality audit to ensure adequate standards are being maintained;
- Consideration will be given to adoption of a scheme of accreditation based upon the Institute of Railway Signal Engineers, as a basis for licensing S&T Technicians;
- All contractors employed upon the System will be subject to the same licensing requirement as directly employed staff.

19.44 System Disruptions

Special procedures, established in the Development Period will be implemented in those instances when a planned or unplanned maintenance activity will cause a disruption to the System operation. Such activities would include:

- Track repairs,
- Catenary repairs,
- Substation repairs,
- Road works in the street sections.
- Third party civil construction.

Subject to meeting environmental requirements work will be performed in either off-peak periods or at night during non-operating periods. All such maintenance activities will be planned well in advance.



Spare Parts

Another important aspect of the Maintenance Strategy will be to monitor and manage the Spare Parts inventory for all areas of the System. These parts will initially be provided under the System Contracts during the erection phase.

Condition Index

To ensure that the assets are maintained throughout the period of the Operating Concession Connex will establish a Condition Index, linked to the Asset Database.

Assets will be maintained to acceptable Condition indices to ensure that at the end of the Concession the assets can be returned to MMRDA in an acceptable condition based on age, fair wear and tear.

Asset Stewardship

The Asset Database produced in the Development Period will be reviewed continuously and updated to reflect changes in the System so as to remain current and valid. Monthly assessments will be performed to ensure its integrity for reflecting the present status of all assets in their respective maintenance life cycles.

19.45 Maintenance organisation

The maintenance organisation takes into account the different tasks to be performed. One group will be responsible for the vehicles and a second group for line and stations. The vehicle group will be active mostly in the Versova workshop and be responsible for the preventive and corrective maintenance as well as for the overhauls of the vehicles. The Line and Station's group will be responsible for the preventive and corrective maintenance as well as for the overhauls of all equipment installed in the line, track, overhead lines, power supply, signalling, telecom as well as in stations like ticketing machines, CCTV, etc.



Line and Station Group

The maintenance team is responsible for the following maintenance tasks:

- Management of all tasks and activities in their field
- Spare parts management
- Station & Infrastructure maintenance
- Civil and Architecture, Builder's Works and Finishes
- Electrical & Mechanical System such as lifts, escalator, air-conditioning, ventilation, plumbing and drainage, etc.
- Automatic Fare Collection System
- Signalling system
- Telecommunication such as radio, CCTV, telephone, network management, SCADA

Vehicle Maintenance

The maintenance team is responsible for all rolling stock used in the Metro system and covers the following tasks:

- Management of all tasks and activities in their field
- Spare parts management
- Preventive maintenance
- Corrective maintenance
- Workshop equipment maintenance

Spare parts procurement will be carried out by a common department responsible for the procurement of all spare parts and third party supplies required for the operation of the Metro system.

The decision about the possible outsourcing of maintenance activities to manufacturers of the subsystems or to specialized contractors will be taken at a later stage during the execution of the project. During the planning phase all activities will be planned and the required service level defined.

Connex has a vast experience in the management of outsourcing contracts in various projects. This experience shall be the base for the definition and organization of the possible outsourcing activities.



Staffing

Staffing requirements for all departments and groups is based on a 3 shift operation to ensure a continuous service level. During the initial operation phase of the Metro system, whilst the systems and equipments are recently installed and not yet all child problems are being cured, shift pattern and staffing will be denser than when the system is stabilized. After 12-18 months shift patterns and staffing shall be reviewed and adapted by taking into consideration the experiences of the initial operations phase.

As well as for Line and Stations Maintenance as well as for Vehicle Maintenance a Maintenance supervisor will be responsible during each shift for the coordination and execution of the works. The Supervisors will report to the Maintenance Engineer, which will be the overall responsible for the respective field.

The initial team for the Line and Stations Maintenance includes the following staff, assuming the outsourcing of the maintenance tasks to specialised contractors or the manufacturer of the equipment:

Staff	Skill Set / Resources
Maintenance Engineer	Direct report to the Station Manager for the maintenance issues.
Maintenance Supervisors	Responsible for the day to day station / mainline maintenance activities, including cleaning of stations
Civil/ABWF Technicians	Multi-skill in Civil / ABWF
E&M Technicians	Multi-skill in M&E systems
Sig. & Comms. Technicians	Multi-skill in Sig. & Comms
AFC System Technicians	To be responsible for the AFC

The maintenance team will be carrying out the supervision of the maintenance contractors who are responsible for maintaining all assets on the system.



Vehicle Maintenance

The shift regime in the workshop will be different for the people working in daily maintenance and the ones involved in the overhaul of the vehicles. Preventive and corrective activities in daily maintenance will be carried out in a 3 shift pattern and overhauls in a normal day shift pattern.

The Maintenance Engineer will be responsible for all activities regarding the maintenance of the vehicles and the operations of the workshop and depot. Daily maintenance will be supervised by the Maintenance Supervisor on duty, which will be working in 3 shifts. The Overhaul supervisor will work only 1 shift. Because overhaul planning and execution starts only after 3 years this person will assist the Maintenance Engineer and the Maintenance Supervisors in various tasks. The Technical Supervisor and Assistants will be responsible for planning, dispatching and quality control and report directly to the Maintenance Engineer. There will be also depot drivers on duty during 24 hours a day, which will report to the Maintenance Supervisor on duty.

Cleaning of the vehicles will be performed at the workshop and shall be outsourced to a specialized contractor.

19.46 Quality assurance

The maintenance organization shall be certified according to ISO 9000. Base for the process definitions and descriptions shall be the already implemented ISO 9000-systems of other Connex maintenance activities around the world.

Planning

For planning, follow-up and monitoring purposes specialized maintenance software shall be introduced already in the construction phase. During the test phase of all systems the processes can be tested and adapted in order to ensure a maximal support of the staff of all levels by this software.



Major Overhauls & Refurbishment

To retain condition of station & infrastructure assets in a way that it enable the Metro system to run an optimum operation to achieve a high customer satisfaction.

The plan aims to achieve the following key goals:

- Changing out of assets/components at optimum timescales,
- Minimising disruption during change-outs by planning resource and asset usage,
- Maintaining assets to a high level thereby reducing the need for unexpected change-outs,
- Keeping abreast of new technologies being used within the industry to enable the MRTS to upgrade the assets in line with industry norms and therefore handing back the system with reduced obsolescence,
- Asset management allowing hand-back of systems at the end of the concession period to be completed with all systems in a good operational condition.

The overhauls & refurbishment details and approach try to demonstrate that the Metro system has considered asset condition throughout the Concession Period paying due regard to the safe operation of the assets and the ability to retain performance of the assets at the high levels required within by the Agreement. Where histories of the asset conditions are not available, the overhaul & refurbishment programme is based on industry norms used by other railway companies.

The overhaul and refurbishment of components and systems will be driven by the inherent design and utilisation of the system concerned, however the maintenance organisation will ensure that the principles of reliability-centred-maintenance are applied to each overhaul & refurbishment programme. This will ensure that each component, system and subsystem is overhauled at optimum interval and in the most effective manner.

Sufficient resources will be put in place to ensure that all systems, subsystems and components are overhauled at the optimum time and with the minimum disruption to the operational service and passengers.



Generic Overhaul & Refurbishment Requirement

Station & Infrastructure System	Activity	Expected Period
Tracks & Track Equipment	Replacement of switches and counter-switches	10 years
	Replacement of switch hearts	
	Servicing of switch motors	
	Replacement of guidance rails in some sections	
	Replacement of OHE support arm	15 years
	Replacement of guidance rails	
Other Station & Track Equipment	General servicing of safety rails	10 years
	Replacement of track transmission cables	
	Replacement of track equipment travel and micro-switches	
	Servicing of emergency sensors	
	Replacement of certain video cameras	
	General servicing of fire detection system	
	Replacement of safety blocks (safety lighting)	
	Replacement of electronic cards caused by obsolescence.	
Automatic Fare Collection System	General servicing of distributors and validation machine	10 years
	Modifications as required subsequent to change of coinage	



Station & Infrastructure System	Activity	Expected Period
Facilities	Refurbishing of offices, meeting rooms, rest rooms.	13 years
Signaling, E&M Installations	Re-working of signaling system	10 years
	Revision of air-conditioning installations	
	Correction of station accesses	
Station Finishing Work	Repairs depending on state of paint and wall coverings and signage	10 years
	Reworking of flooring according to materials and conditions	
OCC	Complete renewal of the process computers, associated software, operator's equipment in the control room such as consoles, videos, keyboards, etc.	13 years
Management data processing, Operation and Maintenance Aid	Renewal of PCs and associated software	10 years



19.47 Electrical Multiple Units

Routine Maintenance

As the electrical Multiple Units (EMU) represents one of the essential elements in the success of the System operation meticulous attention will be given to the maintenance of the EMUs so they are maintained to the levels required to meet availability and reliability performance requirements.

The EMU maintenance organisation will ensure:

- Routine services are performed on time.
- All necessary inspections are completed in accordance with the vehicle maintenance plan.
- Appropriate tests and repairs are completed in accordance with the maintenance schedules.
- Suitable records are maintained detailing the maintenance history of every individual EMU.

To ensure the reliability and availability of the EMU fleet a preventative maintenance philosophy will be employed. Based on the proven techniques developed by Connex from other similar operations and using the EMU manufacturer's documentation Connex can ensure that the vehicle maintenance will be carried out for each EMU as required.

Rolling stock maintenance programme

The concept for the maintenance of the EMU includes all preventive and corrective maintenance work for the whole fleet for the period of 30 years from the beginning of operation. This includes also the wheel turning – depending on mileage – and all overhauls that occur during the contract's period.

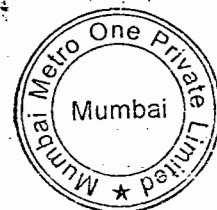

In our bid we have foreseen that the a new work shop in Versova will be build to carry out the maintenance activities in the best way. The workshop infrastructure includes also the installation of a through passing external train wash plant.

With the purpose to guarantee during the whole contract's period in every moment a safe and reliable operation of EMUs, in the offer are included – amongst others – also the following services:

1. Responsibility for the maintenance of the fleet
2. Set-up of the EMUs for the daily operation as foreseen in the rostering schedule
3. Internal and external cleaning of the EMUs
4. Preventive maintenance of the EMUs as foreseen in the producer's technical handbook
5. Corrective maintenance of the EMUs including troubleshooting and failure elimination, repair/exchange or substitution of faulty components and replacements.
6. Prescribed overhaul of the EMUs during the contract's period of 30 years and the foreseen overhaul works.
7. Shunting and set-up of the vehicles inside the workshop and the yard where the vehicle cleaning takes place.
8. 24-hour a day and 7-days a week phone hotline for assistance of train drivers and operational management in case of technical trouble during operation.
9. Set-up and updating of the maintenance history of all vehicles.
10. Certifying of the workshop according to ISO 9001 within one year form beginning of the activity as well the necessary successive audits during the train operation contract's period.
11. Periodical inspections of the vehicles following the indications of the authorities and the manufacturer.
12. Engineering-support from the vehicle producer.
13. Continuous updating of the maintenance documentation.
14. Continuous training of the maintenance staff.
15. Operation and up keeping of the maintenance workshop.



Preventive maintenance

Our bid includes the complete preventive maintenance of the EMUs. Based on the producer's maintenance handbook all necessary operations will be carried out in the maintenance workshop to guarantee a smooth train operation and the necessary operational readiness of the entire fleet.

Following our experience, that we gained in many railway operations all over the world, a daily visual inspection of the EMU will be carried out before commencing the daily operation. Additionally a detailed visual inspection of all EMUs will be carried out once a week. Doing so its possible to guarantee operational safety at any moment.

The maintenance matrix of a 4-car EMU are defined as follows (indicative figures):

Description	Term
V0	Weekly
V1	15'000 km
V2	30'000 km
V3	75'000 km
V4	150'000 km

The overhaul and re-profiling patterns are defined as follows (indicative figures):

Description	Term
R0	200'000 km
R1	750'000 km
R2	1'500'000 km
R3	2'250'000 km



Corrective maintenance

In the scope of work all operations of corrective nature for the fleet of the EMUs, in other words those operations that occur in an un-programmed way. The maintenance offer includes in particular:

- Trouble shooting and elimination in all stations of the network of the tender specification
- 24-hour a day and 7-days a week phone hotline for assistance of train drivers and operational management in case of technical trouble during operation or for further questions
- Repair of damages of the EMUs and the internal decoration

All spare parts and all material which is necessary for carrying out the above mentioned operations, as well as its procurement and storage, will be carried out by the maintenance organisation. For maintenance and overhauls may use for the maintenance new, used, repaired or overhauled components or subsystems.

All terms have allowances to permit, that for any vehicle the corresponding activity can be carried out accordingly to the operational situation and its mileage. The execution of the maintenance operations will be planned by the maintenance workshop in coordination with the train operation management to allow coordinate the maintenance operations with the roster planning.

Major overhauls

Major overhauls of the systems will be performed according to the condition of the equipment and the definitions of the maintenance plan. To carry out the involved works the work shop will be equipped will the necessary machines and tools.

The execution of the overhaul works will be planned by the maintenance workshop in coordination with the train operation management to allow coordinate the overhaul operations with the roster planning.



Cleaning of the EMUInternal cleaning

All EMUs will be cleaned daily and prepared for operation in the maintenance workshop. Additionally there will be a periodical cleaning.

The internal cleaning schedule terms are defined as follows (indicative figures):

Denomination	Term
Punctual cleaning	daily
Basic cleaning	weekly
Basic cleaning 1	Every 30 days
Basic cleaning 2	Every 120 days

Punctual cleaning – every day with the following tasks carried out at the workshop:

- Internal cleaning
- Supply of expendable materials

Basic cleaning – every week with the following tasks carried out at workshop:

- Cleaning of windows and frames
- Cleaning of glass dividing walls
- Wet cleaning of seats

Basic cleaning 1 – every 30 days with the following tasks, which complete those of the inferior level:

- Basic floor cleaning
- Washing and drying of ceiling, walls, lamps etc.
- Washing of waste bins



Basic cleaning 2 – every 120 days with the following tasks, which complete those of the inferior level:

- Cleaning of dividing walls
- Hand cleaning of coach body and front ends
- Cleaning of luggage rack

If required the vehicles will be cleaned also during the day in case of unforeseen events.

The preliminary planning of the cleaning activities during the night in the depot is as follows:

External cleaning

The external cleaning of all EMUs is carried out every 7 days – normally together with the maintenance level P0 – in the through passing wash plant.

EMU Failure

Occasionally a component or sub-system on an EMU will fail. Under such conditions our Failure Management Plan will work to limit the disruption to operations and ensure the appropriate corrective maintenance steps are taken, be they Emergency Running or Depot repairs.

The quick overcome of events that cause railway operation interruptions is of central interest for the operator in order to achieve a high customer satisfaction. Therefore the customers Mainly in situations like this the functional connections inside the organisation express entirely its value. The effective work of the emergency management envisages a close and constructive collaboration between the departments of:

- Infrastructure management
- Passenger information
- Sales department
- Maintenance management
- Vehicle management
- Train driver and train chief staffing management



In case of interruptions the client's satisfaction can increase remarkably providing specific and for the client's need adequate information. To regulate the collaboration and to guarantee the most important functions – which can easily be forgotten in the stress to overcome the interruption – it's necessary to describe the flows in a process diagram and to introduce it in the organisation.

Emergency management

The purpose of the interruption management is to overcome the events in an efficient and effective way increasing the client's satisfaction.

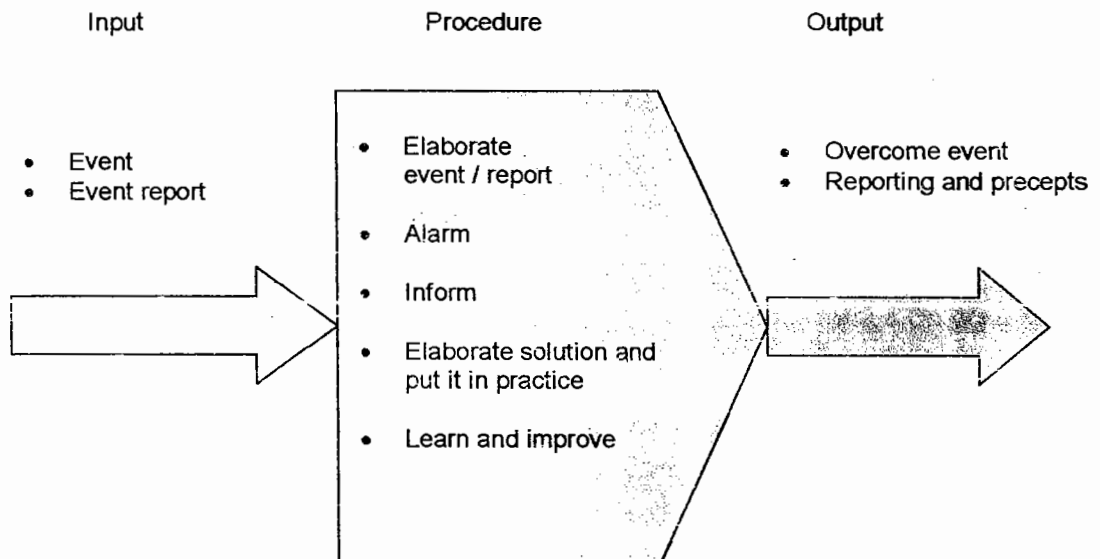

This work is supported by the following communication means and documents:

Communication means :

- Phone
- Mail



- PAGER

Documents

- Alarm list (instructions for what to do in case of interruption)
- Information list (who must be informed in case of which kind of event)
- Daily report
- Events report

Quality measurement

The following markers will be useful for the interruption management process evaluation and the quality evaluation :

- Punctuality values
- Number of cancelled trains
- Client's satisfaction

Emergency prevention programme

The emergency programme starts with the adoption of adequate procedures of early failure diagnostics and a very accurate preventive maintenance, which is able to minimise the failures that compromise the regular passenger service operation. Here below is illustrated at first the repair strategy and then the procedures to adopt in case of unforeseeable emergencies.



The repair strategy is based on the diagnostic maintenance, which is subdivided in the three phases listed up below for the vehicles' activity, utility and condition. The following example shows preliminary work plan for the EMU:

Phase	Activity
During the operation: - during the run - during the stop at terminus	Formulation of diagnosis Punctual cleaning for the client
During the programmed parking: - during the overnight parking - during the longer daytime parking	Maintenance Basic cleaning External cleaning Waste management Repair
On the EMU out of service - during the overnight parking - during the longer daytime parking	Greater maintenance Deeper cleaning Wheel treatment Revision

Failure management

The intervention procedure starts with the train driver's or train chief's report and brings through consultations between these, the maintenance operation management and the vehicle operation management to an evaluation of the failure's seriousness and a decision about the intervention to choose.

The execution of small interventions out of the Gallarate workshop is based on an assistance car with the necessary spare parts and the most important equipment. The staff entrusted for these interventions avails itself of the infrastructure access right at the most suitable site for a repair, which is able to bring re-establish the full operation in less time as possible.



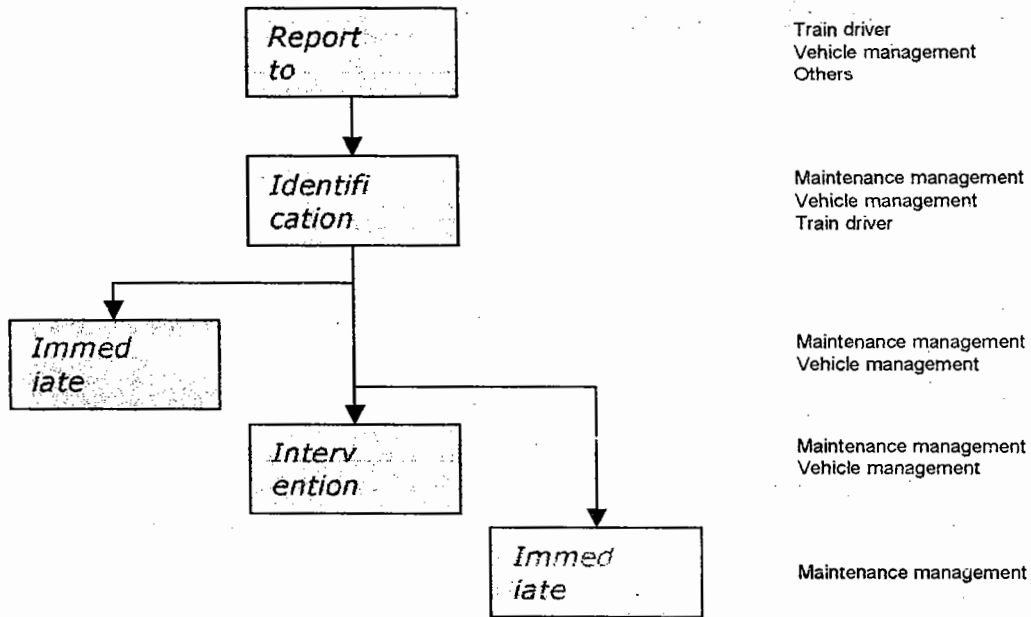

Repair execution

The execution of repairs of different extent, which cannot be carried out in concomitance and/or during the periodical maintenance, is articulated following a three level programme:



Site:

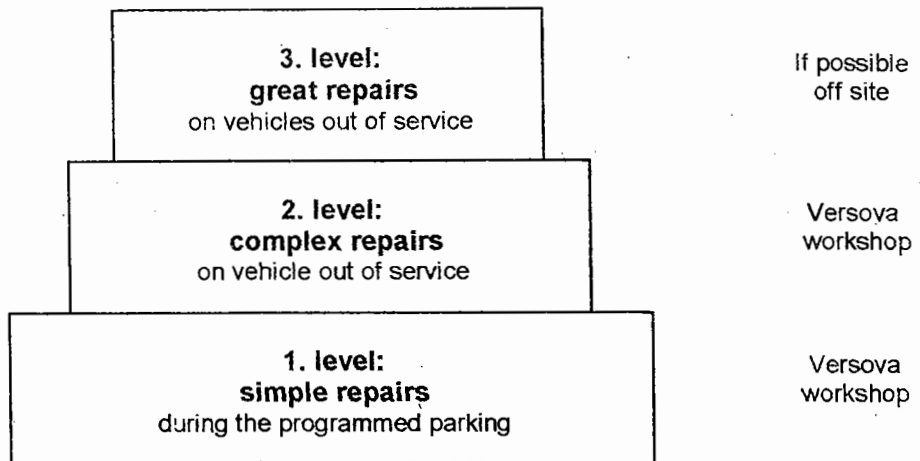

1. Level: Simple repairs

The 1. level includes the execution of repair operation in the Versova workshop as well as in external sites. Therefore it's necessary that the maintenance staff can be employed also out of the Versova workshop. In this phase the following activities are carried out:

- Failure analysis and diagnosis
- Failure elimination according to the capacity (of space, time and spare parts)
- Service of technical assistance (motor power control)

Assuming the outsourcing of cleaning operations, an ulterior employment is planned:

- Inspection of the cleaning operations

2. Level: Complex repairs

Before beginning with complex repairs, the vehicle must be put of service. This putting of service will be accorded between the actors – infrastructure management, vehicle management, train drivers management, maintenance management – and carried out than. After that the repair will be carried out in workshop as soon as possible. If possible, the workshop of Versova will be used therefore.

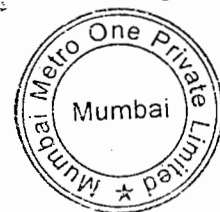

3. Level: Great repairs

The vehicles, which have failures that need great repairs, must be substituted in their service. This will be accorded between the actors – infrastructure management, vehicle management, train drivers management, maintenance management – and carried out than. If the expected repair should exceed the capacity or faculty of the Versova maintenance workshop, it will be carried out externally in specialised repair workshops

19.48 Track

Regular maintenance of the Track will be conducted in accordance with the Track Maintenance Plan. This Track Maintenance Plan will be incorporated into the System Maintenance Plan during the Development Period.

Routine maintenance activities will be planned to limit any disruption to the operation of the System with the highest level of attention applied to ensure the safety of any maintenance employees working on or near the track.

An unexpected failure on the System will be managed in accordance with our Failure Management Plan.

In general, most routine maintenance tasks will be performed in the off-peak periods and at night at the cessation of normal service operations.

The Track Maintenance Plan will also include the 6 monthly tasks to measure noise and vibration. Based on the results corrective action will be taken.

The following tasks will be carried out in the track maintenance:

- Preventative grinding of the track as appropriate.
- Regular machining of the EMU wheels in the work shop.
- Regular servicing of the flange lubricators on the EMU.

All track regions and associated surrounding areas will be kept clean and tidy. These activities form part of the Track Maintenance Plan



19.49 Power System

Regular maintenance of the Power System will be conducted in accordance with the Power System Maintenance Plan, which will be developed during the construction phase. This Power System Maintenance Plan will be incorporated into the System Maintenance Plan during the Development Period.

Overhead Catenary System (OCS)

Routine maintenance activities in respect of the Overhead Catenary System (OCS) will be planned to limit any disruption to the operation of the System with the highest level of attention applied to ensure the safety of any maintenance employees working on or near the OCS.

An unexpected failure of the OCS will be managed in accordance with our Failure Management Plan.

In general, most routine maintenance tasks for the OCS are inspection based and can be performed in the off-peak periods or at night at the cessation of normal service operations. However, some tasks will require the isolation of the power to the OCS for short periods. In these circumstances such work will be performed at night when normal operations have ceased but under the direct control of the Operator.

Sub-Stations

Routine maintenance activities in respect of the Sub-Stations will be planned to limit any disruption to the operation of the System with the highest level of attention applied to ensure the safety of any maintenance employees working on or near a Sub-Station.

An unexpected failure of a Sub-Station will be managed in accordance with our Failure Management Plan.

In general, most routine maintenance tasks for the OCS are inspection based and can be performed in the off-peak periods or at night at the cessation of normal service operations. However, some tasks will require the isolation of the power from a Sub-station for short



periods. In these circumstances such work will be performed at night when normal operations have ceased but under the direct control of the Operator..

19.50 Communication and Information Equipment

Regular maintenance of the Communication and Information Equipment will be conducted in accordance with the Communication and Information Equipment Maintenance Plan. This Communication and Information Equipment Maintenance Plan will be incorporated into the System Maintenance Plan during the Development Period.

Routine maintenance activities in respect of the Communication and Information Equipment will be planned to limit any disruption to the operation of the System with the highest level of attention applied to ensure the safety of maintenance employees.

An unexpected failure of the Communication and Information Equipment will be managed in accordance with our Failure Management Plan.

In general, most routine maintenance tasks will be performed in the off-peak periods and at night at the cessation of normal service operations.

In addition, Connex LUAS will ensure that the Asset Database is adjusted in accordance with any work done in this areas and monitor closely the Spare Parts Inventory as spares are used for replacement.

19.51 Buildings

Regular inspections of the buildings and structures of the System will be conducted in accordance with the Buildings and Structures Maintenance Plan. This Plan will be incorporated into the System Maintenance Plan during the Development Period.

All buildings and structures will be maintained in a condition to meet regulatory and safety requirements.





Source: Connex Light Rail Operation Sydney, Aust.

Cleaning will be included in the Buildings and Structures Maintenance Plan and comprises:

- Keeping System paths clean of debris and litter.
- Removal of all rubbish (including the emptying of litterbins).
- Keeping the surrounding areas of all buildings and structures clean of debris and litter

All work shall be performed to limit any disruption to the System operation or road users.

19.52 Security Systems

Regular maintenance of the Security Systems will be conducted in accordance with the Security Systems Maintenance Plan. This Security Systems Maintenance Plan will be incorporated into the System Maintenance Plan during the Development Period.

Routine maintenance activities in respect of the Security Systems will be planned to limit any disruption to the operation of the System with the highest level of attention applied to ensure the safety of maintenance employees.



An unexpected failure of the Security Systems will be managed in accordance with our Failure Management Plan.

In general, most routine maintenance tasks will be performed in the off-peak periods and at night at the cessation of normal service operations.

Connex will ensure that the Asset Database is adjusted in accordance with any work done in this areas and monitor closely the Spare Parts Inventory as spares are used for replacement.

Access to the Depot sites, in particular the Central Control Room, will be restricted to authorised personnel only. This will be managed by the strict issue of passes and surveillance of usage.

Incidences of vandalism and intrusion will be reported to the local police authorities for their follow-up action.



CHAPTER – 20

DESIGN PROCESS

20.1 Project Definition Documentation

20.1.1 Our experience has show that where a clear and unequivocal common understanding on the scope of works and customer requirements can be arrived at then both Client and Supplier can enhance the value for money and reduce costs of contract supply. The process of project definition, now regularly applied by MTRCL, provides a definition of objectives and service requirements which is mutually agreed between Client and Supplier, before entering into the technical design of the system.

20.1.2 In the initial stages of this process it is recommended that MTRCL with it's wide experience in Railway Operation sits with the Supplier to develop a description of the contract objectives and to subsequently detail the functional and service requirements of the system to be supplied.

20.1.3 Following this the supplier would review with the Client the definition of requirements to reach a binding description on the contract requirements on which the design and delivered system would be based. It is proposed that MTRCL could develop this definition with the Client and/or the supplier and that these deliverables would improve both Client and Supplier understanding as to the supplied system. A brief outline of the process follows:-

20.1.4 Project Objectives

20.1.4.1 This is the high level mission statement which outlines a Project's overall parameters and the objectives of the final product. This document is signed by the Client and is project specific.

20.1.5 Service Requirements

20.1.5.1 The key customer objectives are addressed, including normal and "down graded" operating conditions, operation of irregular modes and emergency configurations of the system. The information outlined in the Service Requirements Documents is project specific.



20.1.5.2 A detailed Customer Service Requirements List is included as an Appendix to the Service Requirements Document should that be required by the Client. This list includes measurable performance standards to be achieved for items such as operational cycle, reliability, accessibility, etc.

20.1.5.3 The design patronage of the railway is usually included as a further Appendix, which provides information to be used as a basis for evaluating the maximum and minimum capabilities of the systems to be supplied. A Schedule of Accommodation defining the type, purpose and size of all spaces required to house system apparatus could be provided as a further appendix.

20.1.6 Functional Requirements

20.1.6.1 This document defines the functions for the software design. It defines the role of the equipment in the control and operation of the line and the degree of human intervention. It defines the contribution the system makes to achieve a safe, successful, reliable and efficient railway. Description of points of interface and system integration could be included.

20.1.6.2 This document is organized by discipline. Typically there are sections covering environmental performance, electrical and mechanical systems and system assurance. Each section contains a series of functional statements, which together constitute a description of the system and an explanation of how the system meets the Service Requirements under each of the operational conditions described in the Service Requirements. Normal and abnormal conditions are specified and the contribution of each system under various failure modes is covered. Each functional statement is referenced to the relevant requirement specified in the Service Requirements.

20.1.6.3 The Functional Requirements are also project specific.

20.2 **Design Management Objectives**

20.2.1 The primary objective of design management is to manage the process of producing a coordinated design for a project, such that the objectives and requirements as defined in the Project Definition Documents can be achieved. This design is to be described with sufficient clarity in working drawings and specifications, such that construction may proceed without hindrance. Essential elements to be addressed during design management are:

- a) Achievement of the project objectives for design as stated in the Project Definition Documents:

This shall be achieved by selection of competent, experienced designers, clear definition of the Client's requirements, pro-active design management and regular design checks, reviews



and audits throughout the design period. There will be a combination of internal checking and reviews by the designers, and external reviews and audits by suitable qualified personnel.

b) Design cost-effectiveness:

This shall be achieved by clear definition of project objectives, use of appropriate, tried and proven design solutions, pro-active design management and regular reviews and reporting of estimated costs.

c) Adherence to design program and buildability of the design:

These are essential components in achieving the overall project objective of completion on time and within budget. Adherence to the design program shall be constantly monitored and reported at regular intervals. Ease of construction, or buildability, is an essential feature to be addressed in all design. It will sometimes override cost effectiveness as a primary objective.

20.3 Design Co-ordination

20.3.1 Accurate design coordination, between design disciplines and adjoining design packages is the most important feature needing to be managed once the design moves from the scheme design stage into final detailing. To ensure proper design co-ordination, there should be:

- a) Clear identification of design interfaces and allocation of responsibilities,
- b) Accuracy and robustness of the design concept and system design for all disciplines,
- c) Provision of design input on time,
- d) A rigorous process and sign off procedure for design co-ordination by the detailed designers,
- e) Constant monitoring of the design process

20.3.2 A schedule giving the type, quality and program of the information to be exchanged and co-ordinated between designers shall be prepared by each design and agreed at the commencement of design. This schedule shall also identify major co-ordination activities within each multi-discipline design package. Monitoring and reporting against the major items in this schedule is required at regular intervals.

20.3.3 The design program must recognize that installation of system wide E&M equipment, station building services and architectural finishes works does not commence until late in the program, the designs for



these elements will be required much earlier in order to allow civil design and reinforcement detailing to be completed to match the civil construction program.

20.3.4 The design program shall incorporate Stage 1 and 2-process confirmation of the size and position of E&M penetrations. Stage 1 shall be the initial design to be issued to the relevant D&C Contractors for provision of their detailed requirements; Stage 2 shall be the final design incorporating the detailed requirements from the D&C Contractor where these can be accommodated. The Phase 1/Phase 2 process shall be regarded as a major design milestone and shall be given due emphasis in the reporting of design status.

20.3.5 Regular design co-ordination meetings are required throughout the detailed design period. These should be structured, rigorous, detailed co-ordination sessions. Attendance by the designer's staff from all relevant design disciplines including system wide designers is considered mandatory to ensure effective and rapid decision making.

20.4 Design Management during Preliminary Design

20.4.1 The purpose of preliminary design is to establish the project scope, cost and program, and to produce the Project Definition Documents to enable a decision to be made on proceeding with the project and to enable the project to be split into manageable packages for the purposes of detailed design and construction.

20.4.2 It must be recognized that substantial changes in scope will occur during this period in response to external influences, e.g. Promoter or Statutory Authorities. However, providing that costs are controlled and the risk to project implementation are reduced by such changes then changes should be acceptable. Risks to the project must be identified and that strategies for dealing with these risks are established. Robust design solutions should be adopted.

20.4.3 Decisions on procurement strategy to be adopted for design and construction will affect the required design documentation and design interfaces. The implications on the design of a preferred procurement strategy are to be established and considered in the discussions on procurement.

20.5 Design Management of detailed Design Consultancies

20.5.1 The initial period of design, usually termed Scheme design, will be to confirm the scope of the design package as established during preliminary design. Adequate consideration shall be given to any changed circumstances since the completion of the preliminary design and responses formulated. The intention should be that at the end of Scheme Design a robust design scope has been established and accepted by all relevant parties.



During the production stages of detailed design the emphasis should be directed towards ensuring thorough design co-ordination between disciplines and between adjoining design packages.

20.5.2 During the construction stage the emphasis must be directed towards completing any outstanding design in accordance with the agreed program and for responding rapidly to design queries arising from construction works at site.

20.6 Design Management of Design & Construct Contracts

20.6.1 Design and Construct (D&C) Contracts will normally be preferred where the design of permanent works is significantly affected by construction methods, proprietary equipment or materials available and where the design objectives can be easily defined. There must be defined in advance so that it is clear what the performance requirements are and what can be left to design development by the Contractor.

20.6.2 Most D&C Contracts will have some requirement for independent checking of the design, either by an independent team within the Contractor's organisation or by an independent checker employed separately. The design reviews undertaken must also provide an evaluation on the overall performance requirements and interfaces.

20.7 Design Consideration Specific for MRTS

20.7.1 The detail descriptions of the design considerations and the design philosophy and the design codes adopted for the elevated corridor have been described in detail in para 7.1 & 7.2 of Chapter 7. Similarly the design considerations for station buildings have been indicated in para 9.12 of Chapter 9. Similarly design standards and design considerations applicable to various subsystems like electrical, traction signaling etc have been indicated in the respective chapters.



CHAPTER – 21

PROJECT AND QUALITY MANAGEMENT

21.1 Introduction

21.1.1 MTR Corporation Ltd. (MTRCL) was established in 1975 for the principle purpose of constructing and operating, on prudent commercial principles, a mass transit railway system.

21.1.2 The present network consists of 50 stations, 5 maintenance depots, 1 Operations Control Centre, with a total of 87.7 route-kilometers and 1050 train cars. Total passenger numbers per weekday currently average above 2.3 million. MTR System is ranked as one of the world's safest and most reliable mass transit system. In 2004, the train service delivery achieved as high as 99.9% whilst the train punctuality attained 99.3%

21.1.3 MTRCL has developed a wide range of expertise for managing multi-disciplinary railway projects from feasibility study, through design and construction to commissioning and testing. With our expertise in using professional planning software tools comprehensive and precise network program can be developed with critical paths identified. MTRCL has developed a wide range of expertise for managing multi-disciplinary railway projects from feasibility study, through design and construction to commissioning and testing. With our expertise in using professional planning software tools comprehensive and precise network program can be developed with critical paths identified.

21.1.4 MTRCL Limited has been very successful over the past thirty years in the project management of a number of new railway lines in Hong Kong from initial conceptual design to final commission and revenue services. The success is mainly due to the implementation of a set of project management and control procedure, which is necessarily required for multi-disciplinary railway projects. In fact similar procedures have also been successfully adopted for the recent metro construction works for Jubilee Line Extension in London and the mass rapid transit system in Singapore. With suitable modifications to suit the local conditions, it is intended to adopt this well proven project management technique for the proposed MRTS in Mumbai.

21.1.5 A copy of the Project Management System as adopted by MTRCL for new railway projects is appended to the end of this chapter.



21.2 Project Quality Manual and Project Procedure

21.2.1 A number of project quality manuals and associated project procedures will have to be developed for the successful completion of the proposed MRTS in Mumbai. The possible list of Project Quality Manuals and Project Procedures may include some of the following:

Project Quality Manual

- Quality Policy
- Quality Management
- Quality Management System Policies
- Organization and Management Responsibilities
- Project Management and Control
- Corporation Standards, Technical Documents and Specifications

Project Procedures

- Use and Disclosure of Information
 - Project Division Recruitment
- Job Description and Job Evaluation
- Prequalification of Consultants
- Selection of Consultants
- Prequalification of Tenderers
- Selection of Tenderers
- Project Cost Control
- Preparation and Administration of Tenders for Engineering Works
- Preparation of Particular Specification for Civil Engineering Works
- Preparation of Particular Specification for E&M Engineering Works
- Major Engineering Works Tender Assessment
- Minor Engineering Works Tender Assessment
- Contract Administration for Major Engineering Works Contracts
- Design Consultants - Claims and Variations
- Design Consultants - Interim Payments
- Preparation of Engineer's Decisions
- Preparation and Invitation of Proposals for Consultancies



- Consultants'/Contractors' Performance Reports
- Contract Closure Report
- Agreements Closure Report for Entrusted Works and Essential Infrastructure Works
- Railway Protection Requirements during Construction
- Handling of Development Submissions from Statutory Authorities for Railway Protection
- Government Entrusted Works - Agreement Preparation and Administration
- Resource Management
- Design Standards Changes and Waivers
- Drawing & CADD Manual - Development and Control
- CADD Drawing Production - Civil & Survey
- CADD Drawing Production - System-wide E&M
- Design Management - Meetings
- Design Management
- Technical Audits
- Preparation of Railway Extensions Energy Consumption Budget Information
- Requirements on Security and Transport Interchange
- Trackside Fire Safety Committee Consultation
- Management of Drawings
- Environmental Aspects Identification and Prioritisation
- Environmental Impact Assessment
- Environmental Site Management
- Foul Water Discharge Licences
- Identification and Control of Hazards for Railway Extension Operational Phase
- Hazard Identification and Control Audit
- External System Assurance Audits
- Inspection of New Railway Projects by the Hong Kong Railway Inspectorate
- Tender Assessment Report (Construction Department)
- Rolling Stock Design Approval Process
- Rolling Stock Inspection and Testing
- Fire Service Installations Inspections
- Site Office Furniture and Equipment (Construction Department)
- Site Vehicles (Construction Department)
- Site and Site Office Security
- Responding to Complaints from the Public (Construction Department)
- Heavy Rainstorm and Adverse Weather Conditions
- Site Allowances
- Project Work Affecting the Operating Railway
- Contractors' Submissions
- Temporary Works

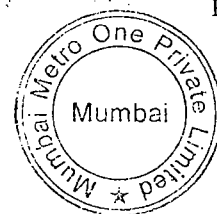

- Insurance and Insurance Claims
- Requests for Information and Site Queries
- Inaugural and Initial Works Meetings with Contractors
- Regular Meetings and Reports
- Site Records Including Photographic and Video Records
- Monitoring of Construction of Railway Related Works Entrusted to Government
- Temporary Ground Anchors Extending Outside the Site
- Buildings and Structures at Risk
- Traffic Diversion Proposals
- Survey Instruments
- Master Survey Control
- Checking of Contractor's Site Surveys and Setting out Works
- Topographic and As Built Surveys
- Wriggle Surveys
- Engineer's Inspection, Test and Survey Check for Civil Engineering Works
- Engineer's Inspection and Test for E&M and Building Services Works
- Overseas Inspection, Testing and Permission to Deliver
- Monitoring of Overseas Supplier's Production Progress and Witnessing of Production Milestones
- Project Emergency Management
- Safety Performance Measurement Scheme
- Defects Liability Handling
 - Correspondence & Communications
- Consultation with Statutory Authorities
- Submission for Approval by Statutory Authorities
- Technical Document Review
- Condition Surveys of Structures
- Railway Alignment Design and Checking
- Railway Gauging and Clearances
- Materials Section Safety
- Materials Section Laboratory Sample Reception and Reporting
- Materials Section Database
- Sampling of Materials for Engineers Tests
- Sampling and Testing Concrete for Acceptance & Compliance Purposes
- Sampling of Steel Reinforcement
- Sampling of Concrete Cores
- Testing of Carriageways for Permeability Surface Regularity and Texture
- Conformance Assessment of Concrete Batching Plants
- Conformance Assessment of Concrete Mix Designs



- Conformance Assessment of Materials & Suppliers
- Conformance Assessment of Laboratories
- Ground Investigation - Planning and Control
- Geotechnical Instrumentation and Monitoring
- Ground Investigation Data Collection, Assessment & Reporting
- Corestore
- Geotechnical Data Collection during Construction Phase
- Software Acquisition Management
- Training
- Preparation, Issue and Revision of Procedures
- Technical Documents
- Correspondence and Communications General
- Document Backup
- Project Papers and Reports
- Project Records
- Controlled Document Issue
- Quality Management System Review
- External Quality Audits
- Internal Quality Audits
- Control of Nonconforming Product
- Pre-qualification and Tender Assessment
- Submission and Approval of Programs
- Works Trains Meetings and Wagon Usage
- Bi-weekly Status Report
- Removal and Reinstatement of Objects Projecting from Buildings
- Land Acquisition
- Preparation of Particular Specification for Building Services Works
- Utilities Management



Chapter 22

CONSTRUCTION PROGRAMME

22.1 Introduction

22.1.1 As stipulated by MMRDA the construction of the elevated corridor between Versova & Ghatkopar will be completed and commissioned within a period of 5 years from the commencement of the concession contract. Accordingly detail planning of the various activities involved has been exhibited in the form of Bar Charts for individual works as well as for the over all project and are enclosed at item 3 of chapter 27 - List of Drawings.

22.2 Mobilization & Planning

22.2.1 The organization chart required for the construction of the project has been enclosed at item 2(B) of Chapter 27 – List of drawings. Action would be initiated by the JV for formation of SPV and the Key Officials of the JV along with supporting staff for engineering & construction will be established in the existing office of REL at Santacruz Mumbai. The staff of the Technical Consultant for Planning & Project Management (MTR) would also be established for initial Planning, Design & Engineering. A Project Manager with appropriate qualification and experience would be identified by the JV and placed in position along with the supporting experts and staff of various disciplines such as Civil and Structural Engineering, Track, Electrical Works, Rolling Stock, Signaling, Telecommunication & other allied works would be identified and placed in position progressively. A detail planning of the Manpower requirement during various periods of construction would be made and staff selection should be planned accordingly. All the infrastructure necessary for office and field work would be installed on priority. The field office will be established in the Depot area near D.N. Nagar Station. Priority would be given for field mobilization of infrastructure casting yard, store yards and workshops and site offices etc. Simultaneously survey work will be taken up for setting out the alignment centre line and marking of curves, transitions and column positions and other critical locations. GTS benchmarks will be transferred and established all along the alignment and suitable intervals. Action will be initiated for Geotechnical investigations and trial bores and analysis of the soil data at column locations. A detailed station area planning, designing and locations at site would be initiated. Land to be taken over from MMRDA would be jointly surveyed and delineated on site. Detail investigation of the Underground services of the alignment would be carried out by digging trial pits if necessary and coordinating with the Municipal corporation and other state government authorities. Similar Action will be taken for establishing liaison with western & central railways for assistance required from them at locations crossing the railway tracks by the corridor alignment. Negotiations would be



conducted with established companies for supply of ready mix concrete and approving the mix designs and analyzing the qualities of their sources of materials. Similar action will be taken by the respective departmental heads for electrical, Rolling stock, Signaling & Telecommunication officials for their part of mobilization activities and their planning & designs for their system. All the above activities have been planned to be completed within a period of 6 months, some of which would be extended to 12 months as indicated in the programme.

22.3 Construction Activities

22.3.1 The detail design of the way structures and of other disciplines i.e. Electrical, signaling etc. would be carried out through the Project Management Consultants and tender document with bills of quantities will be prepared for finalizing the construction agencies. It is proposed to have two main contractors for construction of Civil Works and around three contractors for the construction of station buildings and one labour contractor for Track Work as the volume of work involved for each agency would be very high and the timely completion with the best quality to international standards would be required, large size construction groups who are well known for their quality construction and completing within time would be identified and about four to five agencies would be pre-qualified for way structures. This prequalification would be based on their financial strength, experience on similar bridge works & piling and prestressed concrete girder works and having sufficient in-house equipment and manpower ability and an outstanding in-house Planning, Procurement, administrative and financial setup with large number of experienced engineering staff particularly those who have experience in working in cities like Mumbai. Companies having established systems for engineering, construction, safety and environment would be selected for the construction for ensuring timely completion. These construction agencies would be provided with a bonus clause for completion before time. It would also be ensured that SPV Management and the Project Management Consultant gives prompt decisions and approvals for various issues connected with construction and will be paid promptly for the works executed. The actual construction of the civil works for the main alignment has been planned for commencement from the sixth month and will be completed in a period of 36 Months. The detailed activities for the various detailed components of the Civil Work has been exhibited in the detailed Bar Chart for Civil Works enclosed at item 3 of Chapter 27 – List of Drawings.

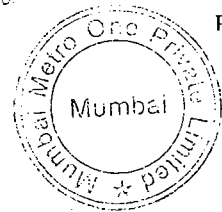

22.4 Station Building

22.4.1 The Project Management Consultant would appoint Architectural Firm for Design & Planning of Station buildings. A separate expert agency for building design would be associated for structural design of the various components of the buildings. Three independent construction agencies for station buildings have been planned with 4 to 5 groups of stations for agencies. The conceptual architectural drawings will be got approved from the top management of MMRDA. The construction agencies will be selected from among the experts real estate contractors who have good record and in-house infrastructure and quality and timely construction. The broad specifications should be adopted for the station building would be approved by MMRDA. If necessary, coordination approval required from BMC will be entrusted to these contractors. The field construction of the Station Building will commence from the 6th month and has been planned for completion in a period of 3 years. The detailed activities involved in the construction of station building has been shown in the programme for Civil Works attached at item 3 of Chapter 27 – List of Drawings.

22.5 Track

22.5.1 The design of the track structure with reference to curvature, gradient, with super elevation and transitions, track fittings & ballasted track in the alternative depot and the detail methodology for execution and the track parameters and the tolerances necessary including LWR would be prepared by the Project Management Consultants. It is proposed to design, plan & procure all the track materials by the JV on the advise of Project Management Consultant and award a contract for laying of track to agencies available around Mumbai having similar experience in the past. Initial work for design and planning would be done during the first 12 months and the actual execution would be commenced in the 12th month immediately on the launching of Girders and has been planned to complete within a period of 33 months. Enough float is available in these activities. The detailed actives involved in track work has been shown in the programme for civil works enclosed at item 3 of Chapter 27 – List Of Drawings.

22.6 Electrical Works

22.6.1 Initial mobilization of staff, site office and workshops including construction infrastructure and field survey would be completed within the first 6 months. The design, drawings, quantity estimation and placing of orders on equipment and preparation for tender documents including finalization for OHE contract will be completed in the first 15 months. The work of fabrication, erection of OHE mass & wiring of OHE conductors including insulation for adjustment of OHE would commence from the 15th month completed within a period of 36 months. Electrical works for power supply, wiring of station building, erection of escalator, lifts & substation equipment has been planned for commencement from 36th month and programmed for completion within a period of 12 months.



Wiring and erection of SCADA equipment, testing of OHE substations and commissioning the electric supply has been planned for commencement from 48th month and programmed for completion within a period of 12 month with sufficient float in these activities. A bar chart for the detail activities for the electrical works has been enclosed at item 3 of chapter 27 – List of Drawings.

22.7 SIGNALING & TELECOMMUNICATION

22.7.1 Initial mobilization and design of the system has been planned during the first 6 months as the work involves procurement of materials some of them from international sources has been planned from 6th month and completed by 24th month. Installation of OCC equipment, way side equipments and track side equipment has been planned for commencement from 18th month and completed in a period of 24 months. Other equipments including electronic equipments, train indicator PA system would be installed from 30th month and programmed for completion within a period 6 months. OFC laying and network equipment will commence from 30th month and would be completed with in a period of 12 months. Testing of equipments & ATC system would commence in 42nd month and competed within a period of 6 months. Final testing and commissioning of all systems will commence at 48th month and completed by 54th month. Enough float has been provided in the various activities to cover dependency elements of other work. Detailed bar chart for the various activities involved in signaling and telecommunication works has been shown in item 3 at Chapter 27 – List of Drawings.

22.8 ROLLING STOCK

22.8.1 Initial mobilization, finalization of design, specifications and preparation of tenders for procurement of rolling stock have been planned for completion within a period of 6 month. Invitation and finalization of tenders for procurement of rolling stock would commence from 6th month and planned for completion within a period of 9 months. Design and manufacture of prototype rake would commence in the 15th month and would be completed by 24 month. The transportation, testing & commissioning the prototype train including correction to design etc. would commence in 24th month and will completed by 33rd month. Final manufacture of the bulk order, transport and commissioning of the balance trainsets would commence from 33rd month and completed in 48th month. Enough float has been provided for testing and commissioning of the system so as to get the system certified go through the trial running period and commence operation in 60th month. Detail bar chart of the various activities have shown in item 3 for Chapter 27 – List of Drawings.



22.9 OVERALL BAR CHART

22.9.1 An over all bar chart of all the activities has been summarized and enclosed at item 3 of Chapter 27 – List of Drawings. An S'Curve showing the overall percentage of works proposed to be completed during the various periods have also been shown in the overall bar chart. The major mile stones for the construction activity have been indicated in the overall Bar Chart as indicate below:

Mile Stones	Months	Cumulative %Progress
M1	6	5%
M2	12	15%
M3	24	40%
M4	36	65%
M5	48	90%
M6	60	100%



CHAPTER – 23

ENVIRONMENT MANAGEMENT

23.1 Environment Management

Environment includes water, air, land & the inter relationship which exists among & between water, air & land and human beings, other living creatures, plants, micro organisms & property.

The Main Objectives are:

23.2 Environment Aspects

23.2.1 Significant environmental Aspects :

- Impact
- Environmental Impact
- Environmental Pollutant
- Environmental Pollution
- Nuisance
- Construction site
- Waste

23.3 Plant and Equipment

- Potential Source of the Air Pollution:
 - i) Exhaust coming out from different equipments.
 - ii) Dust generated as the result of different construction activities.
 - iii) Dust and suspended particles during transportation of material.
- Mitigation Measures Including Contingency Planning.



- Air Monitoring Control Plan (AMCP).
- Monitoring Of SPM (Ambient Levels).
- Presentation and Interpretation of Results.
- Dust Control.
- Noise Control Measures (PPE).

23.4 Mitigation Measures

- Scheduling truck loading, unloading & & hauling operation so as to minimize noise impact near noise sensitive locations and surrounding communities.
- Locating stationary equipments so as to minimize the noise impact on the community.
- Equipment and plant are stopped when not in use.
- We will use only well maintained machinery at site, all equipment and vehicles will serviced as per the maintenance schedule.
- Silencers and mufflers on constructing equipment shall be properly fitted and maintained.
- Schedule the work to avoid simultaneous activities that would generate high noise levels.
- Construction of temporary physical noise barriers whenever required.

23.5 Monitoring

23.5.1 The Noise monitoring and control plan shall provide:

23.5.2 Specific night and day time construction activities, monitoring locations, equipments, procedure and schedule of measurement and reporting method to be used.

23.5.3 A scaled plan indication monitoring location, including measurement to be taken at construction site boundaries and nearby residential zone.

23.5.4 A record of noise characteristics of power mechanical equipment proposed to be used during day time and night time, of proposed working methods and of potential noise level reduction measures.

23.5.5 Immediate notification when measured noise level exceeds allowable limits.

23.5.6 A reporting procedure whereby noise-monitoring data is furnished to the employer's representative on monthly basis.



23.5.7 Ambient noise generated by a passing train shall comply with the relevant ambient noise standards as specified by Central Pollution Control Board (CPCB) Bidders shall provide and adopt noise mitigation and abatement measures at critical sections along the alignment to comply with the said regulation.

- Locations of Noise Sensitive Receivers (NSR) will be identified in consultation with MMRDA.
- Existing ambient noise levels along MRTS alignment will be measured to generate baseline data.
- Noise levels less than 75 dBA will be achieved at 25 m from rail, by using 1 to 1.5 m high noise barriers.
- Full enclosure will be used in selected areas to achieve the norms specified by CPCB.

23.5.8 Noise Controls -

- To avoid incidence of noise in coaches, special materials in the interior of the car bodies will be used with acoustic insulation, as well as for the car floor, to prevent ingress of noise from the under frame and the bogie.
- The shock absorbing type of mountings equipment will be designed to produce minimum noise to ensure noise level within the permissible limits specified. The track structure will be designed with adequate resilience to ensure minimum transmission of noise to the adjoining area by use of rubber pads. Adoption of pneumatic suspension in the coaches would also be considered to ensure noise limits within limits.
- At specialized location like hospitals, schools and temples and other critical areas, special arrangement of increasing the height of the parapets of the bridge deck on either side for adequate length by use of noise absorbing materials will be made. Please also refer to the Environment Management Plan described under Chapter 23 of section 5, Vol. II of our technical proposal

23.6 Presentation and Interpretation

23.6.1 The monthly report will include (but not be limited to) the following:

- Executive Summary.
- Brief mention of constructing activities.
- Monitoring results under AMCP and NMCP.
- Interpretation of monitoring results, significance And influencing factors.
- Graphical representation of monitoring results over past four reporting periods.
- Measure of control spill under SPCP.
- Action taken on recommendation under site inspection programmed or specific direction.
- Summary of complaints, results of investigation and follow-up action.
- Future key issues.



23.7 Water Pollution Control

- Spillage Prevention and Control Plan.
- Drip Pans.

23.8 Waste Control

23.8.1 Identification of Waste.

23.8.2 Information & Training – Regarding Waste handling

- Organic Waste
- Combustible Waste
- Hazardous Waste
- Recycling Waste
- Minimization of Waste

23.9 Hazardous Materials

23.9.1 Handling of Hazardous Materials

- Necessary training to handle the hazardous material will be imparted to the workmen deployed on handling such materials.
- Authorized transport will be deployed for transportation of such material.
- Proper handling tool shall be provided to all.
- PPE shall be strictly enforced during loading and unloading.

23.9.2 Storing Hazardous Materials

- Proper platform, rack should be used for storing materials.
- Different type of materials should be stored at different places.
- Filled in and empty drums / bags / cylinders shall be stored separately at earmarked places.
- Raw materials should be stored properly providing access for fire fighting operations.
- Fire fighting facilities should be available.
- MSDS should be available in stores.



- Proper bin card (Store Record) should be maintained.
- Concrete platforms wherever required should be provided.

23.9.3 Usage Disposal

- Empty drums, bags, containers recyclable & such material should be disposed off through approved agents only. Hazardous waste should be disposed off as per MSDS, manufactured instructions following all applicable rules and regulations. Spent batteries should be either returned to supplier or sold to authorized.

23.9.4 Site Conditions

- Discharge, sewer / storm water connection
- Prevention of Mosquito Breeding
- General Housekeeping

23.10 **Emergency Preparedness and Response**

23.10.1 Objective

- To facilitate the rapid implementation of relief or emergency measures during incident, disasters and prevent minor incidents which can develop into potential major incident.

23.10.2 First Aid Box

- A fully equipped First Aid Box is available at site. It should consist treatment couches and wash facilities, lockable cupboards and sufficient medical supplies.

23.10.3 Contents of First Aid Kit

- Dressing cotton
- 25mm Roller bandage
- 75mm Roller bandage
- Potassium Permanganate crystals or solution.
- Iodine Bottle
- Adhesive Plaster
- Scissors / safety pins



- Dettol
- Burn Ointment (Burnol)
- Antiseptic Cream
- General Medicines
- Record of first aid treatment given to any worker is recorded in register.

Necessary tie up with local hospitals is made for emergency treatment.

23.10.4 Procedure

- A List of emergency contact numbers is displayed at site.
- First Aid Box is made available at site.
- Whenever work is in progress a vehicle is kept at site.
- Engineer / Supervisor is trained to give first aid to injured person with the help of safety staff.
- First Information Report (Police Report) is prepared in case of major incident. Administrative staff or other senior staff member will contact nearest police station for first incident report.
- Administrative staff should arrange for emergency vehicle / Doctor for injured if necessary.
- Injured person is admitted in the civil hospital with the help of Labour Contractor.
- Site In Charge / Administrative staff / Safety Officer informs to Head office in case of major accident.
- If Company's Vehicle is not available, any other vehicle available with the Sub-contractor / Supplier / client may be used on request.



CHAPTER - 24

SAFETY MANAGEMENT

24.1 Introduction

24.1.1 General

24.1.1.1 Safety is the most important & critical part on the project sites. Safety policy is established to ensure the safe working condition at site and at every stage of construction activity. Safety management has been introduced at site to ensure safety at site.

24.1.2 Purpose

24.1.2.1 Safety management consists of Responsibility matrix of each cadre at site, Emergency plan, Procedure of review for safety function, Safety training procedure, Storage & House keeping at site, First Aid Treatment and other basic guidelines for each activity which are helpful to execution staff to ensure the safe working conditions at the site at all time.

24.1.2.2 Updating of Safety Plan

24.1.2.3 Safety plan will be reviewed and updated every six month or as per requirement.

24.1.3 Objective

The Objective of the Safety Management System is:

- To provide safe working condition at site during execution at any time.
- To provide identification of potential hazards and establish safe guards against hazards.
- To provide response to emergency situations.
- To strive to continuously improve Safety Management Skills.
- To create safety awareness among all Staff and Site Personals to achieve zero incidents at site.



- To carry out investigations on occurrence of any incident and carry out corrective & preventive actions.
- Identify Line of Responsibility for Safety function.

24.2 Elements of Safety Management System

24.2.1 In compliance with the regulations, the following safety elements are included:

- Safety Policy
- Safe Work Practices
- Safety Training
- Safety Committee Meeting
- Safety Promotion
- Incident Investigation and Analysis
- In-House Rules and Regulation
- Safety Inspection
- Emergency Preparedness Plan
- Maintenance of Equipments
- Hazard Analysis & Safety Audit
- Environmental Management

24.2.2 Safe Work Practices

a) Objective

- The objective of the Safe Work Practice is to eliminate or reduce to a minimum, the risk of death or injury to the Persons and damage to the properties and assets during the execution of work.



b) Procedure

- When making work assignments to Sub-Contractor, REL safety person will educate the Sub-Contractor's staff and his staff about safety practices, work methods and personal protective equipments.
- REL Staff and Sub-Contractor's staff shall be responsible for determining that each worker has the proper protective equipments and suitable tools for the assignment.
- Sub-Contractor shall provide documentation of Compliance with Project Safety Plan in advance of starting the work. Safety Officer shall notify to Project Manager or Deputy Project Manager of any safety and / or security documentation (information for work passes, crane certificates, operator's certificates, Declaration by the Sub-Contractor), which are outstanding for more than 7 days.
- Project Manager shall take the necessary actions to correct such deficiencies.

24.2.3 Safety Training

a) Objective

- The objective of safety training is to equip personnel with the knowledge, skill and attitude, which will enable them to perform their duties in a safe manner.

b) Procedure

- All workers and staff should know about the potential hazards that may exist on construction site, elimination of hazards precaution to be taken to perform all work safety.



- The Safety Officer shall liaise with the Construction Department and maintain a program for the training of workers to meet Project Safety Plan and statutory regulations in advance of work.
- The Safety Officer shall keep an updated record of the training courses completed by workers.

24.2.4 Safety Committee Meetings

a) Objective

- Objectives of the Safety Committee meeting is to assemble people with particular responsibilities for safety so that they can formally address issues and take appropriate actions in relation to the achievement of the work site safety management objectives.
- REL will organize a safety committee meeting with the following main aims:
 - Confirm if the management of safety and health is being properly carried out by all the parties concerned.
 - Ensure that the construction work is being performed safely and smoothly, complying with safety and rules and regulations.
 - Conduct Safety inspections of the entire site prior to the Safety Committee Meeting.
 - Co-ordinate and control congested or hazardous working conditions of the sub-contractors.
 - Resolve safety issues submitted by any Sub-Contractors.
 - Increase Sub-Contractors' safety knowledge and safety awareness.
 - Enforce Safety Training Programs.



- Promote and maintain housekeeping and waste disposal at the highest standards.
- Review safety statistics of previous month.
- Review of the laid down Safety Practices and their improvements, if necessary.

24.3 Incident Investigation and Analysis

24.3.1 Objective

24.3.1.1 To ensure that every accident, incident and near misses is investigated thoroughly to determine it's cause.

24.3.1.2 Corrective and preventive measures are implemented to prevent recurrence of similar accident.

24.4 In-House Safety Rules and General Safety Rules & Regulations

24.4.1 Objective

24.4.1.1 The objective of Safety Manual and In-House Safety Rules and Regulation is to provide all personnel with a common understanding of their obligation and responsibilities with respect to the achievement of the work safety.

24.4.2 Procedure

24.4.2.1 A set of In-house Safety Rules and Regulation will be established and maintained, which gives a clear instructions to the Personnel in each of the following general areas:

- Safe Operation of Plant, Machinery and Equipments.
- Maintenance of Plant, Machinery and Equipments.
- The handling of materials.
- The reporting of hazards and incidents.
- The use of personal protective equipments.



- The reporting of incidents.
- Cleanliness of the work places.
- Storage of Gas Cylinders.

These rules will be communicated and issued to all Sub-Contractors.

All new workers will be briefed on the In-House Safety Rules and Regulations.

24.5 In-House Safety Rules and Regulations

- 24.5.1 Appropriate personal protective equipments, such as Helmet, Safety Belts, Gloves and Goggles etc. are provided and worn at all time.
- 24.5.2 Only electricians are authorized for any electrical connections or disconnections & D.G. Operations.
- 24.5.3 Do not touch any hazardous chemicals or unknown item at the site.
- 24.5.4 Work place is kept neat and clean. Wastage / Debris are removed after the completion of the work on daily basis.
- 24.5.5 Access is kept free from any obstruction at site.
- 24.5.6 During transportation at site, no body is authorized to seat except driver on the vehicle.
- 24.5.7 During heavy rain, improper lighting, heavy wind blowing at site, nobody is deployed on work at height.
- 24.5.8 The Contractor will not deploy any labor having age below 18 years on the job. No Children are permitted inside the working area.
- 24.5.9 Persons / Equipments / Material enter or exit the site only through the gate designated.
- 24.5.10 Only license holder drivers / operators are allowed to operate any vehicle and mobile power equipments.
- 24.5.11 All vehicle and equipments are inspected by a competent person prior to use.



24.5.12 All the safety related points / decisions are put and discussed in site internal weekly meeting.

24.5.13 Separate training program for the following are carried out frequently:

- First Aid
- Scaffolding

24.5.14 Separate / Trained gang for scaffolding is deployed for safe condition at site.

24.5.15 For the hazardous activities like working at elevated level, blasting etc. work permit system is introduced.

24.6 SITE SAFETY INSPECTIONS

24.6.1 Objective

24.6.2 The objective of the site inspections are as follows:

- To ensure that workers carry out safe work practices during the execution of their tasks in accordance with safety requirements.
- To check and correct immediately any un-safe acts / conditions.
- To maintain a register of daily site safety inspection check list for audit purpose.
- To demonstrate management commitment towards safety.

24.7 Hazards Analysis and Safety Audit

24.7.1 Objective

24.7.1.1 The objective of the analysis is to provide a means whereby hazards are identified and managed in a way that eliminates, or reduces to acceptable level, the risk of an accident occurring.



24.8 Emergency Preparedness & Responses**24.8.1 Objective**

24.8.1.1 To facilitate the rapid implementation of relief or emergency measures during incident, disasters and prevent minor incidents which can develop into potential major incidents.

24.8.2 First Aid Box

24.8.2.1 A fully equipped First Aid Box is available at site. It is easily accessible and marked.

24.8.2.2 First Aid and temporary care given to the victim of an accident or sudden illness till the treatment from the doctor is made available. All execution members are trained for giving First Aid treatment. First Aid room is prepared at main office building. It consist treatment couches, hand wash facilities, lockable cupboards and sufficient medical supplies. Necessary tie up with local hospitals is made for emergency treatment.

24.8.2.3 Contents of First Aid Kit:

- Dressing Cotton,
- 25 mm Roller Bondages,
- 75 mm Roller Bondages,
- Potassium Permanganate crystals or solution,
- Iodine Bottles,
- Adhesive Plasters,
- Scissors / Safety Pins,
- Dettol Bottles,
- Burn Ointments (Burnol),



- Antiseptic Creams,

- General Medicines,

(Record of First Aid treatment given to any worker is recorded in the register).

24.8.3 Procedure

- A list of emergency contact numbers is displayed at site.
- First Aid Box is made available at site.
- Whenever work is in progress a vehicle is kept at site.
- Engineer / Supervisor is trained to give first aid to injured person with the help of safety staff.
- First Information Report (Police Report) is prepared in case of major incident. Administrative staff or other senior staff member will contact nearest Police Station for the first incident report.
- Administrative staff should arrange for an emergency vehicle / Doctor for injured, if necessary.
- Injured person is admitted in the Civil Hospital with the help of Labor Contractor.
- Site In-Charge / Administrative Staff / Safety Officer informs to Head Office in case of major accident.
- If company's vehicle is not available, any other vehicle available with the Sub-Contractor / Supplier / Client may be used on request.

24.9 **Safety Manual**

24.9.1 Introduction



This Safety Manual outlines the safety rules and regulations, which must be followed by all personnel within work site area.

It is produce primarily for the use of supervisory staff who are required to ensure that the rules and procedures are brought to the notice of Sub-Contractor's employee and that such rules and procedure are strictly followed.

Any person uncertain of the safety manual should consult the Safety Department for clarification. Any person doing work requiring special precautions or more detailed guidance on safety procedure he should discuss with Safety Department prior to commencement of his work.

24.10 Safe Work Practices – Machines And Equipments

24.10.1 Machinery

- Machines are none of the leading causes of injuries. Improperly trained operators are often the victims. So until the operator has checked the machine and is authorized to run it – hands off!
- The following must be remembered when operating a machine:
- Before turning on a machine, safety check shall be made for – people clearance, Guards in place and emergency stops in working condition.
- The machine shall not be left running by the operator.
- Loose clothing or jewelry shall not be worn while operating machines. Also long hair must be tied.
- When a machine is out of order, a warning sign “Machine under Repair” must be displayed.
- Machines shall be kept clean.



24.10.2 Hand Tools

Many hand tools are available for specific jobs or for specific materials. The right tool for each job shall be used correctly and safely.

The following shall be noted when using hand tools:

- The right size spanner to fit the nut shall be used.
- All the files shall have a handle.
- Chisels and punches with mushroomed heads should be ground
- Hammerheads shall be tightly wedged on their shafts.
- Split wooden handles shall be renewed.
- Edges of cutting tools shall be kept sharp.
- Hands shall be kept behind the cutting edges when working.
- Tools shall be kept in boxes or racks when not in use.
- Sharp edges of tools that are to be stored or carried shall be protected.
- Tools that are worn or damaged beyond repair shall be scrapped.
- The correct tool for the job shall be always used.

24.10.3 Maintenance Work

- Before maintenance work is started, it should be made sure that all machinery comes to a complete stop.
- The safety guards shall be replaced when work is completed.



- Proper co-ordination between the maintenance crew and site personnel during maintenance work shall be ensured.

24.10.4 Electricity

When performing any work that involves electricity, no matter what the voltages are:

- It has to make sure that all the safety precautions and procedures are followed.
- A check for defective cables, plug or sockets shall be carried out.
- Electrical equipment shall not be over loaded.
- Any equipment that sparks or stalls shall be switched off and disconnected.
- Cables shall not trail across the floor.
- The equipment shall be disconnected when not in use; cable shall not be pulled to disconnect; the plug shall be pulled.
- Kinking, twisting, binding or crushing of cables shall be avoided.
- All electrical equipment shall be kept clean and dry.
- The operative shall not stand on the wet area while using electrical equipment.
- No bare wires to be installed in the plug sockets.
- Only industrial plugs must be used to install any wires to the sockets.

24.10.5 Abrasive Wheels / Disc Machines

- Abrasive wheels, cutting discs and related machines shall have the manufacturer's specification plate (Stating voltage, maximum speed etc.)



- Hand held tools shall be equipped with an operating switch or lever requiring constant hand or finger pressure to operate (Dead-man Switch).
- The use of such tools / equipments shall be limited to the safe design capacity of these tools. They shall not be modified.
- Safety guards must be in place and maintained at all times.
- Person using such tools / equipments must be experienced / trained in the safe operation, and authorized by his supervisor to use and operate them. They shall carry the necessary certificates with them.
- They shall be maintained in safe working condition for use at all times.
- Such tools / equipments shall be inspected at least once every month and records shall be maintained.
- Electrical driven tools / equipments must be checked and inspected by a licensed electrician.
- Defective tools / equipments shall not be used.
- Tools / equipments found defective or unsafe, must be tagged 'Unsafe – Do not Use'.
- Portable type must be removed from the work area immediately. Non-portable type must be de-energized or lockout.
- Appropriate personal protective equipment, such as safety goggles, face shields, hand gloves etc. shall be worn when grinding or cutting.

24.10.6 Pneumatic and Hydraulic Powered Tools

- Only tools in safe and serviceable condition shall be used.



- Person using pneumatic and hydraulics powered tools must be trained in the safe use of such tools.
- Only authorized person shall be allowed to use such tools. The use of such tools must be supervised.
- Pneumatic and hydraulics powered tools must be checked before use.
- Coolant shall be used to dispense the heat and reduce the possibility of sparks generated by the tools.
- Pneumatic and hydraulic powered tools shall have a fail-safe device such that they top automatically when the operator releases his hold.
- Air must be shut off before attempting to disconnect the air hose from the airline. Any air pressure inside the line must also be released before disconnecting.
- Using the air supply of such tools from the hose or otherwise for blowing off dust on machine, clothing or any surfaces is strictly not permitted.
- Pneumatic and hydraulic power lines must be positioned so as not to be liable to damage or resent a tripping hazard.
- Compressed air lines shall have outlets directed downwards toward the floor, away from the operator.
- Pneumatic and hydraulics powered tools must first be disconnected from the supply before any adjustment or repair to be made.
- All joints and couplings shall be inspected before the start of the day's work
- Safety valves shall be checked and maintained to ensure functioning condition.



24.10.7 Air Receivers

- All air receivers shall be fitted with a pressure relief valve and shall have the safe working pressure clearly marked upon them.
- Every air receiver shall be subjected to an annual test, which shall be carried out by a duly authorized person. The results of the tests shall be recorded and the records shall be kept available for inspection by the employer's representative and a copy of certificate displayed on the receiver.
- The connection couplers on compressed airlines shall be securely fixed together and have whip lash or be wired at the joints in order to ensure that the joints do not come apart when charged with compressed air.

24.11 **Safe Work Practices – Hot Works**

24.11.1 Welding And Cutting

- All hot works has to be carried after obtaining a Hot Work Permit from the authorized person.
- All welding and cutting apparatus shall be inspected daily. Defective apparatus and equipments shall be replaced or repaired. Regular monthly testing and inspection is necessary.
- Keep fire extinguishers available and check area before leaving.
- Combustible items such as gas cylinders, rubber hoses and debris shall be removed or shielded from heat, sparks and slag from welding and cutting.
- Welding or cutting work at elevated places shall be conducted only under safe conditions (a safety harness shall be worn).
- Welding or cutting in confined areas is required; the space shall be well ventilated. During the work, the concentration of oxygen in the air must be



greater than 20%. When working in a confined area, the workers should at least be paired (2 persons) to monitor hazards in preventing accidents.

- Where electric welding work is carried in such a manner as to involve risk or persons employed (other than persons employed in the welding process) being exposed to the electric arc flash, effective provision shall be made by screening or otherwise to prevent such exposure.
- Domestic LPG cylinders shall not be used for any hot works.

24.11.2 Electric Welding

- It shall be ensured that the shield, helmet or goggles contain the correct filter glasses.
- Adequate protective clothing shall be worn by the operative.
- When necessary, screens shall be used to protect neighboring workers.
- It shall be ensured that the cables and connections are in good condition and firmly attached. Joints in the cables to be avoided, if any joints are required it should be joined with proper and approved connectors.
- It should be made certain that the welding equipment; bench or work piece is properly earthed.
- It should be checked that the electrode holder is fully insulated and it is always placed on an earthed surface when not in use.
- When the ground is damp the operative shall stand on an insulated mat.
- Good ventilation in the welding areas shall be maintained, but oxygen SHALL NOT be used to ventilate confined spaces.
- Welding near flammable materials shall be avoided.



- Crane operators found tampering with any safety devices shall be dismissed from site immediately.

24.12.2 Erection Work – General

- The erection work plan and procedure shall be checked thoroughly by Contractor's construction supervisor. Warning signs of "NO ENTRY" and safety ropes shall be provided by work supervisor.
- The strength of the road on the route of the crane shall be checked by the Engineer. The valid certificate shall be displayed on the lifting machines, Cranes or winches shall be locked or broken when not in operation.
- Sub-Contractors performing work requiring daily / regular lifting operations – such as piling, decking, erection of major plant – shall provide a person competent in lifting operations who will be appointed by REL using appointed letter as the lifting supervision for the Sub-Contractor's work.
- The lifting supervisor will fill out and submit to the Station Manager / Safety Engineer a check list before lifting operations are carried out.

24.12.3 Erection By Crane

- Lifting work shall begin only after confirming by preliminary check that the crane is set up satisfactorily. The crane access and its position must be checked for stability to prevent crane from toppling. Site Engineer must check and ensure that the load bearing of the ground is adequate for the lifting work. If the crane will be positioned a long period of time, the appointed Site Engineer must carry out daily check to ensure no deterioration of the ground condition.
- The crane shall be secured horizontally and steel plates or square timbers shall be placed under the outriggers firmly, and then secured with knock pins after being set in position.
- The operator shall not leave the crane or winch during lifting work.



- Welding shall never be done in an enclosed vessels, drums or tank which contained flammable materials unless they have been purged by steaming or any suitable methods as per the contents of the vessels tested and certified safe to work on.
- No welding shall be done on the weld material degreased with solvents unless it is absolutely dry.
- No welding shall be allowed on galvanized or coated metals without taking proper precautions against fumes generation.
- No attempt to weld enclosed vessels of tanks until safety precautions has been taken.
- All the welding cables shall be kept clear of roads and walkways. It shall be secured to overhead fixtures where possible.
- Welding cables and power cables shall never be tied together and always to be kept separated.

24.12 Safe Work Practices – Hoisting, Lifting, Erection

24.12.1 Lifting Equipments

While using lifting equipments:

- Know the correct weight of the load before it is lifted.
- Do not operate if you are not trained. Never overload when lifting materials, keep to its safe working load (SWL).
- Examine lifting equipment before use.
- Don't lift if the load is not secured.
- Do not stand or walk under a suspended load.



- The inclined angle of the boom during operation shall not exceed the range of 30-80 degrees unless otherwise specified for the machinery. When using the jib its length must be minimized. An angle indicator shall be provided for the crane operator to visually check the boom angle. Crane booms shall be lowered to the ground level and the hook shall be secured to the specified position when the crane is not in use.
- When moving cranes, the boom must be lowered and a boom walker must be provided in addition to the crane operator. Crane boom must not be operated closer than 2 m to any overhead line or electric transmission wire. When it is absolutely necessary to operate closer than 2 m, special permission must be secured from the Employer's representative and arrangements made to cover or de-energize the circuit line.
- Only authorized persons with a license / training shall be permitted to operate the crane or do slinging for lifting equipment.
- The strength of the ground where the crane is to be placed shall be examined. If necessary, reinforcements, such as installation of steel plate shall be arranged.
- The foreman and signalman shall be assigned for each erection work under an operating system established for the work. They shall stand where they can observe the loading operation and be clearly visible to the crane operator during the crane work. A uniform signal system shall be used for flags, transceivers or hands for signaling.
- The capacity of the crane to be used for erection shall be determined after careful consideration.
- Total lifting weights and the center of gravity of equipment to be erected shall be carefully re-checked before commencing erection work.
- Load indicators shall be installed on the cranes.
- Before starting the work, the condition and functioning of the brakes, limit switches, over hoist prevention devices, wire ropes and lifting devices, shall be



checked and inspected and the crane shall be operated on a trial basis without a load. As a preliminary check, the equipment shall be lifted and held 10 cm from the ground. In this state all elements shall be checked and inspected to see if they are functioning properly. If the risky conditions are detected, the lifting work shall stop immediately. Lifting work shall not be carried out during bad weather, such as strong winds or heavy rains.

- Crane shall never be loaded in excess of the manufacturer's stipulated rating.
- Lifting load for each crane shall be controlled within 90% of the maximum lifting load (to read from load indicator). The lifting load shall include dead load of lifting, hook, rope etc.
- During the lifting work, the operation shall be carefully supervised to prevent hasty lifting, prolonged suspensions and lifting beyond the limit. Abrupt lifting and stopping shall be prohibited.
- Simultaneous rotation and sudden lifting or rotation and boom movement shall be prohibited.
- The boom shall be slowly rotated so as not to produce centrifugal forces on equipment or materials being lifted.
- Workers shall be forbidden to ride on lifted equipment or material when lifting or swinging is taking place.
- The crane's wire rope shall be rolled up entirely after the work is completed.
- Safe Working Load (SWL) for the crane shall be conspicuously displayed on the crane body.
- The crane shall have a valid operating license issued by the competent authority. The validity of the license shall be of six months.
- The lifting hooks shall be provided with a safety catch.

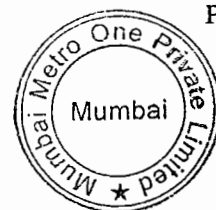

24.13 SAFE WORK PRACTICES – TRENCHING AND EXCAVATION

24.13.1 Notification

- No person shall carry out any excavation work without first notifying the relevant authority.
- Such notification shall be submitted in prescribed Excavation Work format to the relevant authority.
- Every notification shall be accompanied by detailed layout plans, sectional plans of the excavation and method of construction with projected schedule of work.

24.13.2 General Requirements

- No personnel be permitted to enter any excavated area unless seat piling shoring or other safe guards necessary for the protection are provided.
- Where any person in excavation is exposed to the hazards of falling or sliding of materials from any bank or side more than 1.5 m high above his footing, adequate piling and bracing shall be provided against the bank or side to eliminate such hazard.
- The excavation site and its vicinity shall be checked by a competent person after every rains storm or other hazard increasing occurrence and the protection against slides and cave-ins shall be increased, if necessary.
- Temporary sheet piling installed to permit the construction of a retaining wall shall not be removed until the wall has developed its design strength.
- Where banks are undercut, adequate shoring shall be provided to support the overhanging material.



- Excavated material and other superimposed loads shall be placed at least 1 meter setback from the edge of open excavations and trenches and shall be so piled and retained that no part thereof can call into the excavation or cause the banks to slip or cause the upheaval of the excavation bed.
- Banks shall be stripped of loose rocks or other materials which may slide, roll or fall upon persons below.
- Open sides of excavation where a person may fall more than 1.5 m shall be cordoned off by approved rigid pipes or A-frames barricades and suitable warning signs shall be put at conspicuous positions.
- All excavations in public places have to be cordoned off.

24.13.3 Piling, Shoring And Bracing

- Planks used, as shoring shall not be less than 50 mm thick. The maximum spacing between horizontal stringer and Wales shall be such as to keep the planks within their safe bending stress. Shores and braces shall be of adequate dimensions for stiffness and shall be so placed as to be effective for their intended purposes.
- Each end of each stringer piece shall be separately braced.
- Earth supported shores or braces shall bear against a footing of sufficient area and stability to prevent their shifting.

24.13.4 Excavation Works Near Existing Utilities

- Machine excavation near existing utilities and hand excavation around existing utilities will be conducted under the full time Supervision / site Engineer.
- Persons involved in excavation works near existing utilities without the approval are subject to disciplinary action that may include removal from the project.



24.14 Safe Work Practices – Scaffolds, False Work

24.14.1 False Work

- False Work is any temporary structure used to support a permanent structure during the erection.
- False Work shall be carried out in accordance with the relevant applicable Indian Standards.
- An experienced and qualified Engineer shall be assigned to co-ordinate all major false work schemes.
- The design of the temporary structure shall include requirements such as material inspection, foundation and erection checklists, This shall be specified prior to carrying out any false work.
- Safety provisions in accordance to statutory requirement shall be incorporated in the design of the false work.
- All false work shall be subjected to safety inspection.

24.14.2 Safety Provision

24.14.2.1 General Scaffolds

- In the erection, maintenance and subsequent dismantling of scaffolding, all the regulations and acts shall be adhered to. In general, it is required that the scaffold shall be firstly of adequate strength stability, good construction and material and secondly that the related permanent structures shall be at all stages of construction be safely supported against collapse. All scaffold materials shall be free from patent defects.



- The works supervisor shall assign a competent approved person (CA) to the site to supervise all aspects related to the erection, maintenance and dismantling of scaffold.
- The scaffolding erectors should use safety lines to anchor their body harness in the process of erection and dismantling. These safety lines should be securely anchored onto an expansion bolt anchored on to the roof of the building or to any other adequately strong anchorage. Scaffold erectors should not be allowed to work on scaffold without the use of body harness, safety lines and helmets.
- Handrails and intermediate guard rails shall be provided along each ledger level approximately 1.1m and 600mm above each ledger respectively. Where safe access to the scaffold from the building or structure is not available, ladders should be provided. This is to avoid workers having to scale a scaffold. Toe boards should also be added onto platform on scaffolds to prevent materials falling over it.
- Materials should not be allowed to be discharged from the side of the building and hitting the scaffold structure as serious damage such as broken ledgers and dislodged tie-backs could result.
- Scaffolds should not be used as supports for hoisting materials unless it is designed for and approved.
- During scaffold erection, the site supervisor (CAP) shall carefully keep watch, provide "NO ENTRY" and "DANGER OVERHEAD" signs, and if possible rope off the related work area for safety and provide warning lights for night works.
- All scaffolding that are in the process of erection, alteration and dismantling shall be properly indicated and warned to make sure that no workers will use such scaffold. Access to the scaffolds can only be allowed, after it is fully completed and checked. All scaffolding structure build must display either. A tag indicating that the scaffolds is "NOT SAFE FOR USE" if it is incomplete, has been damaged or weakened.

OR



- A tag indicating that the scaffolds are "SAFE FOR USE" if the works are completed checked for safety and certified.
- Excess materials shall not be placed on the work floor or runway, avoid storage or deposit.
- Materials, tools and equipments on the working platform which may be displaced or fall from the scaffold shall be secured adequately.
- Barricade all open sides of scaffold with proper guard rails and replace all missing or damaged guard rails.
- All working platform shall be fully and properly boarded.
- Provide proper ladders or steps for workers to gain access from one level or another.
- All other general safety requirement for site work shall be observed.

24.14.2.2 Suspended Scaffolds

- Erection of any suspended scaffold shall comply with standard scaffold practice.

24.14.3 Platform

- Safe working platform shall be provided for person to work at height, Proper means of access (such as stairs, ladders and ramps) must be provided
- The working platform shall be tagged with the safe load (in terms of number of persons) hat can be carried out by the platform.

24.14.4 Safety Net

- Safety nets used at the construction site shall comply with acceptable standards.



24.14.5 Ramps And Ladders

- Ramps and ladders shall be provided to secure safe passage for workers required for work at a height or depth of more than 1.2 m
- As a rule, the slope of ramps shall be limited to 30 degrees. For slopes of more than 30 degrees, rungs and guard rails shall be provided. The rungs shall be spaced 30 cm apart and nailed firmly.
- One platform shall be provided for every 7m in height.
- All ladders, ramps, runways and through surrounding areas shall be free of materials, machines and obstructions at all time.

24.14.6 Material Handling

- Materials, rubbish and tools shall not be thrown from upper levels to lower levels or to the ground.
- When lowering or moving materials on the ground, suitable devices, such as chute, bag, container with a rope or a device tied securely with rope shall be used.
- During the work, the foreman shall carefully keep watch; provide "NO ENTRY" and "DANGER OVERHEAD" signs and rope off the related work are for safety.
- Excess materials shall not be placed on the work floor or runways.
- Materials, tools and equipments which may be displaced or fall shall be secured adequately.



24.15 Safe Work Practices – Electrical

24.15.1 General

- Temporary electrical work shall comply with applicable Indian Standards electrical safety requirements.
- All electrical works shall be performed by qualified and trained electrical workers. Equipment shall be locked or secured to prevent starting by unauthorized persons.
- Live parts of apparatus and wiring shall be effectively guarded to protect all workers or object from coming into contact.
- All equipments and wiring shall be checked daily by the operator before starting work. All electricity circuits shall be grounded.
- Warning signs or posters, such as "DANGER", "NO ENTRY" shall be displayed at dangerous places, such as substations, switch boxes and overhead or underground cables.
- All cables should be run at high level, at a height not obstruction the movement of people and equipment. No naked wires shall be inserted in to plug sockets.
- Only industrial sockets shall be used.
- Joints in the cables shall not be allowed between the local switch box and the equipment.
- Jointing of cables shall only be done with proper cable connectors.
- Jointing of cables shall not be done with plastic insulation tapes.



24.15.2 Transformer Bank

- Transformer banks or high voltage equipments shall be barricaded with a fence. The entrance shall be locked.
- For transformer-banks, warning signs of "DANGER – LIVE", "NO ENTRY" and "NO WATER SPRAYING" shall be posted. Posters shall show the name of the Supervisors or Maintenance Engineer. Primary and secondary voltage and capacity also be displayed.

24.15.3 Circuit Breaker

- Circuit breakers shall be provided for all electrical equipment complying to the relevant Indian Standards, such as conveyors, winches, pumps, grinders and similar equipments to prevent workers from being injured by electric shock.
- Automatic leakage breakers shall be installed in switch boxes.

24.15.4 Switch Box

- Temporary switch boxes shall be constructed of metal with a water proofed door and locked.
- Switch boxes shall be installed adjacent to the work area at a height of 0.8m or more from the ground or working floor.
- An ample number of switch boxes shall be provided with adequate capacity. Switches and fuses shall be of proper capacity for the circuit protection. Over loading beyond the rated capacity shall be prohibited.
- The name of the person responsible for inspection and maintenance of the switch box shall be marked on every switch box. Name or number of equipment served by each switch shall be tagged on the switch.
- Switch boxes shall be grounded with vinyl insulated copper wire.



- Using copper or steel wire instead of a fuse shall be strictly prohibited. Multiple connections of cables from one switch shall be prohibited.
- When inspection or repairing, switches shall be cut out and the switch box locked.
- All connections shall be done by cable glands and lugs.

24.15.5 Welding Machine

- Before welding machines are used, insulation shall be tested and certified to be in safe operating condition.
- Low voltage shock prevented devices shall be provided for all welding machines.
- Welding machines shall be installed 100 cm or more away from the switch box.

24.15.6 Movable Wiring

- Wiring shall be cab-type cable having a dielectric strength of not less than the rated voltage of 600v. Cable having ample capacity to the load shall be used. Cable with any external damage shall not be used.
- All cables shall be installed away from any steel materials such as wire rope, steel frame, scaffold etc.
- Three / four core cable shall only be used.

24.15.7 Grounding

- To prevent short circuits or electric shocks, special precautions such as grounding shall be taken for wiring work where metal scaffolds or steel structures are erected. Grounding shall be secured by connecting the wire to an earth rod buried firmly in the ground. Brass or steel bolts and nuts shall be used for grounding terminals of all electrical equipments.



- Earth Leak Circuit Breakers (ELCB) shall be provided to every temporary electrical installation.
- All distribution boards shall have earth fault relay in the incoming.
- Power cables are to be earthed from the armor of the cables with clamps.
- All welding generators shall be provided with double earthlings. One at the neutral and the other at the external casing.

24.16 Safe Work Practices – Confined Space

24.16.1 Confined Space Entry

- Entry and working in confined spaces must be in compliance with all the relevant statutory codes and requirements.
- An "Entry / Excavation Permit" must be obtained from authorized officer before entry or working in Confined Space.
- The conditions stipulated in the "Entry / Excavation Permit" must be totally complied with before entry, While working inside and after the work.
- Pipelines attached to Confined Space must be physically disconnected and blanked or capped.
- Radioactive sources must be shielded or removed. The lighting and power sources used shall meet the REL requirements.
- Lock & tag procedure shall be applied where necessary to prevent isolated supply from being activated prior to entry into Confined Space.



24.16.2 Confined Space Environment

- Hazardous or toxic material must be removed and cleaned out of the Confined Space.
- The atmosphere in the Confined Space shall be able to sustain life and must be free of combustible and toxic gas / vapor.
- Checking and testing of the atmosphere in the Confined Space shall be done prior permit approval and prior to entry.
- Forced ventilation or exhaust fan shall be provided to maintain the atmosphere safe. The atmosphere conditions must meet REL requirements.
- If the work is being performed inside the vessel, which can generate any toxic or flammable vapors or produce an oxygen deficient atmosphere, testing shall be done continuously while work is being performed.

24.16.3 Rescue Plan

- A rescue plan shall be developed and reviewed with all personnel entering Confined Space and all standby personnel.
- The Rescue Plan shall include:
 - An immediate call for assistance of back-up person.
 - Assist persons/s in Confined Space by providing breathing air mask or assistance in getting out of the Confined Space.
 - Help the person out of Confined Space by using safety harness, if unconscious.
 - Report within 30 minutes, air bottle or air-supplied respirator to enter the Confined Space to move the person out.
 - Get medical assistant on the standby.
 - Activate medical emergency procedure.



24.16.4 Danger, Warning & Caution Tags

- The purpose of providing danger, Warning & Caution tags / boards / signs is for protecting personnel, plant and equipments from injuries or damaged by maintaining safe methods of installation and starting up operational circuit's plants and equipments.
- All personnel will be trained on the procedure.

24.16.5 Illumination

- Temporary illumination for maintaining safe working condition shall be provided and will be in accordance with the applicable Indian Standards and requirements. All levels shall be provided with illuminations, including platform, concourse, under platforms, tunnels and any other places as directed by the Employers representatives.
- REL shall provide temporary general illumination in each room or basement. The lighting shall be not less than 200 lux. With a minimum of 2 luminaries room or basement.

24.17 **Safety Equipment**

Safety Officer in consultation with Project Manager decides the requirements of PPEs for the project. Minimum inventory level for the same is decided and maintained by the store as per direction by the Safety Officer / Project Manager.

24.17.1 Personal Protection

- Suitable protective equipments required for personnel, such as clothing, goggles, gloves, respiratory equipment, helmets, ear plugs and safety shoes are provided by the safety officer / store and are worn where required.
- Safety Officer / Execution team train workers and ensure that all employees wear appropriate personal protective equipments and is maintained in good condition.



Safety Officer / Execution team do not commence work till workers have used protective equipments.

24.17.2 PPEs

Head and Scalp – Hard helmets are worn properly under the following conditions:

- In any area posted as hard hat area
- Beneath any overhead work, including areas below ladders (e.g Ground man working with a man on a ladder), scaffolds, open gratings and other openings.
- In any other area where a head bumping hazard is present.

24.17.3 Eyes And Ears

Safety goggles are worn by everyone who is:

- doing mechanical / electrical work
- In an area where mechanical / electrical work is being done, or
- In an area where chemicals are stored or handled (which includes, but is not limited to all laboratories)
- Carrying out drilling / chipping work at site
- Working in areas that are designated by the Supervisor.

24.17.4 Fingers, Hands and Wrists (Glove Rules)

- Gloves suitable for the job being performed are worn unless the job can not be done with gloves or unless wearing Gloves increase the hazard.

24.17.5 Toes, Feet And Legs

- An Industrial-quality leather shoes, safety shoes or toe protection are worn at all times by persons doing mechanical / electrical / construction work or in an area where such work is being performed. Safety shoes or toe protection are also worn in all area so posted.
- Robber shoes with safety toe protection are used on jobs with the potential for chemically hazardous conditions.

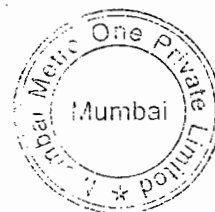

- Foot guards are worn while using hammers, tempers and similar equipments.
- Minimum stock is always kept site. Minimum level is prepared based on judgment of Site In Charge / Safety Officer.

24.18 Safety Aspects For Machineries

24.18.1 Authority And Authorization

- The person is thoroughly scrutinized, tested and provided with required documents prior to providing him the authorization to operate their respective machinery / vehicles by site administrative officer.
- Only the authorized personnel are deployed for operating machinery / vehicles.
- Every employee is provided with a proper identity card.

24.18.2 Safety Guidelines – Machineries

24.18.2.1 Concrete Mixer

- All gears, chains and rollers of concrete mixer are adequately guarded to prevent damage / danger.
- Concrete mixer hopper is protected by side railing and operators have to ensure before lowering the skip that lower portion of skip is clear.
- Wire rope of Hopper is checked for its condition periodically.
- Hopper hoist and anchoring brake are checked / adjusted.
- Clutch of the Skip hoist is checked and adjusted while slipping occurs.
- Nothing is kept inside the motor enclosure.
- Be sure that motor fan guard is secured firmly.
- Be sure that wiring is properly connected and installed.
- Ensure double earthing is done for electric mixers.

24.18.2.2 Concrete Vibrators

- Vibrator unit are completely enclosed and belt transmitting the power to the unit adequately guarded.

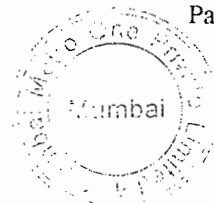

- Electrically operated compacting vibrators are totally enclosed and are protected against over loads by suitable overload relays and are effectively earthed.
- Ensure that sufficient length of cable is provided to the vibrator.
- Ensure electric starters are fixed firmly on the stand.
- While needle is inserted in the vibrator, ensure needle rod is firmly locked.
- Ensure that proper lubrication of needle inner core is done.

24.18.2.3 Concrete Pump

- Piping is laid on adequate supports and secured to prevent movement.
- Pipelines are not attached to temporary structures such as scaffolds and form work supports as the forces and movements may effect their integrity. Pipe connectors particularly those installed at height are secured against dislodgement. Pipeline is checked for leakages and the couplers are to be properly tightened to avoid spillage and movement.
- While cleaning the pipeline using a ball always ensure that a ball catcher is provided to catch the ball at the end of pipe line. Ensure that persons are at safe distance while cleaning operation is being carried out.



CHAPTER – 25

LIST OF CONSTRUCTION EQUIPMENT

Sr.No.	Name of Equipment	Nos	Remarks
	(A) CIVIL ENGINEERING		
1	Excavator – JCB (0.5 Cubic meter capacity)	5	
2	Dumpers – TATA / LEYLAND (6 Cubic meter capacity)	20	
3	Welding Generators – 400 AMPS	5	
4	Concrete Vibrators – Internal x 4 Nos.	4	
5	Vibrating Needles – 60 mm x 8 Nos.	8	
6	Transit Mixers	20	
7	Concrete Pumps	5	
8	Batching plants	5	
9	Long line casting beds less than 25 meters x 2 Nos.	2	
10	Long line casting beds more than 25 – 31 meters x 6 Nos	6	
11	Long line casting beds more than 31 meters x 2 Nos.	2	
12	Normal moulds x 16 Nos.	16	
13	Pier segment moulds independent x 4 Nos.	4	
14	Pier segment moulds for long lines x 8 Nos.	8	
15	Reinforcement Jigs x 20 Nos.	20	
16	Goliath Cranes 80 tone capacity 30 meter span x 4 Nos.	4	
17	Goliath Cranes 10 tone capacity 20 meter span x 12 Nos.	12	
18	Total stations x 2 Nos	2	
19	Auto levels x 2 Nos.	2	
20	Theodolite x 2 Nos	2	
21	Hydraulic Jack 150 T capacity Stroke 250mm Single Acting with threaded ram, lock nut and base plate of size 300mm x 300mm x 25mm.	2	
22	Power Pack to operate the above jacks simultaneously.	1	
23	Hydraulic Jacks 200 T capacity 300mm strike single acting with threaded ram & lock nut plate of size 400mm x 400mm x 25mm.	4	
24	Power Pack to operate the above four jacks simultaneously.	1	
25	Longitudinal launching jacks 40 t capacities, Double acting with a stroke of 1200mm including over valve.	1	
26	Power Pack to operate above jacks.	1	
27	Hydraulic Jack 100 T capacity Stroke 300mm Single Acting with threaded ram, lock nut and base plate of size 300mm x 300mm x 25mm.	4	
28	Hydraulic Jacks 100 T capacity 300mm strike single acting with threaded ram & lock nut plate of size 300mm x 300mm x 25mm.	2	
29	Power Pack to operate the above 2 jacks simultaneously.	1	
30	Central Hole jack for pulling 26.5mm Mac alloy bar with stroke of 200mm.	1	
31	Hydraulic Jack with Central hole capacity 60T and stroke 200mm for moving suspenders of 40mm dia Mac alloy bars.	2	
32	Hydraulic jacks for transverse movement of slider beam capacity 20T, Double Acting, stroke 600mm.	2	
33	Jacks for Supporting and Lowering the span after launching capacity 200T single Acting with lock nut maximum height 250mm.	4	
34	40mm dia Mac alloy bars as suspended each of length 6.5m.	22	
35	Nut of dia 51mm to suit 40mm dia suspenders.	44	
36	26.5mm dia Mac alloy bar for side shifting over rear trolley.	11.8	
37	80 T capacity hoists resting over brackets of launching girder for fitting of segments.	1	
38	Mono jacks for pulling slider beams capacity 10 T.	2	
39	10 T Hoist for shifting supports operating on monorail attached to bottom of L.G.	1	
40	20mm dia wire rope for pulling sliders beams.	60	

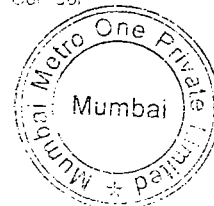

41	40mm dia rope assembly for lifting segments.	100	
42	Thimble for 40mm dia wire rope assembly.	44	
43	Aluminum grip foil for 40mm dia wire rope assembly.	88	
44	Bolts for Launching Girder splices 24mm dia. HSFG bolts	2100	
45	Pre – stressing Equipment	2	
	(B) ELECTRICAL		
46	Trailer for carrying girders	2	
47	Rail Cum Road Vehicle	2	
48	Trailer for Standard Gauge	2	
49	Heavy duty trucks	4	
50	Ladder trolleys	8	
51	Pull lifts, jacks	1	
52	Signaling & Telecommunication Trailer for carrying girders	2	
53	Rail Cum Road Vehicle	2	
54	Trailer for Standard Gauge	2	
55	Heavy duty trucks	4	
56	Ladder trolleys	8	
57	Pull lifts, jacks	1	
58	25 T E.O.T Crane	2	
59	15 T E.O.T Crane	2	
60	10 T floor Operated E.O.T Crane	2	
61	15 T Whiting Jacks Synchronized control	8	
62	Under floor wheel crane	1	
63	Surface Wheel Lathe	1	
64	Wheel Turner & Burnisting Machine	1	
65	Vertical Burnisting Machine	1	
66	Horizontal Burnisting Machine	1	
67	Cement Lathes	3	
68	Bogie Testing Fixture	1	
69	Fixture Bogie Quariw	1	
70	Traction Motor Test Bed	1	
71	Transformer Oil Filtration Plant	1	
72	Slotting M/C	1	
73	Shaping M/C	1	
74	Electronic Testing Kits	L/s	
75	Compressor Testing Bed	1	
76	Brace Equipment	1	
77	Test Bed Panel	1	
78	Spring Testing M/C	1	
79	Grit Blasting Plant	1	
80	Coach Painting Booth	1	
81	Automatic Coach	1	
82	Jigs And Fixtures	1	
83	Measurement & Testing Equipments	L/s	
84	Measuring Handling Equipments	L/s	
85	Simulator	1	
86	Auxiliary Relief Train	1	
87	Tower Wagon	1	
	(C) S & T		
88	Rail cum – Road vehicle	2	
89	Trailer for standard gauge	2	
90	Heavy duty trucks	4	
91	Jack and pull lift	LS	
92	Small Tools	LS	
93	Workshop machinery	LS	
94	Construction, furniture stationery	LS	



CHAPTER - 26

LIST OF CODES

26.1 Civil

Foundation

- IS 2911 (Part 2)
- IS 1892 Code Of Practice For Site Investigation For Foundation
- 2911 (Part 1 To 4) Code Of Practice For Design And Construction Of Pile Foundations.
- IS 1888 Method Of Load Test On Soil
- IS 1904 Code Of Practice For Design And Construction Of Foundation In Soil: General Requirement.
- IS 456:2000 Code Of Practice For Plain And Reinforced Concrete.
- IRS/Bridge Structure And Foundation Code 1985 With Addendum & Correction Slip No.13
- IS 1950 (Part 1): 1973 Code Of Practice For Design And Construction Of Raft Foundation.
- IS 6403: 1971 Code Of Practice For Determination Of Allowable Bearing Pressure On Shallow Foundations.
- IS 8009 (Part 1): 1976 Code Of Practice For Calculation Of Settlement Of Foundation For Transmission Line Towers And Poles.
- IS 2720 Methods Of Test For Soils.
- IS 1498 Classification & Identification Of Soils For General Purposes.
- IRC 78 Standard Specification And Code Of Practice For Road Bridges.

Load

- IS 875 (Part 1): 1987 Code Of Practice For Dead Load (Other Than Eq) For Building And Structure.
- IS 875 (Part 2): 1987 Code Of Practice For Imposed Load
- IS 875 (Part 3): 1987 Code Of Practice For Wind Load
- IS 875 (Part 5): 1987 Code Of Practice For Special Load And Load Combinations.
- IRS/Bridge Rule 1964 With Addendum & Correction Slip No.30

Safety

- IS 1641: 1988 Code Of Practice For Fire Safety Of Buildings (General): General Principles Of Fire Grading And Classification.
- IS 1642: 1989 Code Of Practice For Fire Safety Of Buildings (General): Details Of Construction.
- IS 1893 (Part 1): 2002 Criteria For Earthquake Resistant Design Of Structure.
- IS 1893: 1984 Criteria For Earthquake Resistant Design Of Structure.
- IS 4326: 1993 Code Of Practice For Earthquake Resistance Design And Construction Of Buildings.
- IS 13920: 1999 Code Of Practice For Ductile Detailing Of Reinforcement Concrete Structure Subjected To Seismic Forces.
- IS 7205: 1975 Safety Code For Erection Of Structural Steel Work.

Steel

- IS 1566: 1982 Specification For Hard Drawn Steel Wire Fabric For Concrete Reinforcement.
- IS 1785 (Part 1): 1983 Specification For Plain Harddrawn Steel Wire For Prestressed Concrete Coldrawn Stress Relieved Wire.
- IS 1785 (Part 2): 1983 Specification For Plain Harddrawn Steel Wire For Prestressed Concrete Asdrawn Wire.



- IS 1786 : 1985 Specification For Strength Deformed Steel Bars And Wires For Concrete Reinforcement.
- IS 2062 : 1984 Steel For General Purpose.
- IS 2090 : 1983 Specification For High Tensile Steel Bars Used In Prestressed Concrete.
- IS 2502 : 1963 Code Of Practice For Bending And Fixing Of Bars For Concrete Reinforcement.
- IS 2751 : 1979 Recommended Practice For Welding Of Mild Steel Plain And Deformed Bars For Reinforced Concrete.
- IS 6003 : 1983 Specification For Indented Wire For Prestressed Concrete.
- IS 6006 : 1983 Specification For Uncoated Stress Relieved Strand For Prestressed Concrete.
- IS 9417 : 1989 Recommendations For Welded Cold Worked Steel Bars For Reinforced Concrete.
- IS 14268 : 1995 Specification For Uncoated Stress Relieved Low Relaxation Seven Ply Strands For Prestressed Concrete.
- IS 1363 : 1992 Hexagon Head Bolts Screws And Nuts Of Products Grade C
- IS 1367 (Part 6) : 1980 Mechanical Properties And Test Methods For Nuts With Specified Proof Loads.
- IS 1367 (Part 13) : 1985 Hot Dipped Galvanized Coating On Threaded Fasteners.
- IS 5624 : 1970 Foundation Bolts.
- IS 3757 : 1985 High Strength Bolts.
- IS 6623 : 1985 High Strength Structural Nuts.
- IS 8500 : 1992 Structural Steel-Microalloyed (Medium And High Strength Qualities)
- IS 6649 : 1985 Hardened And Tempered Washers For High Strength Bolts And Nuts.
- IS 5374 : 1975 Tapered Washer For I Beams.
- IS 800 : 1984 Code Of Practice For General Construction In Steel.
- IS 1024 : 1979 Code Of Practice For Use Of Welding

Concrete

- IS 1343 : 1980 Code Of Practice For Prestressed Concrete.
- IS 4926 : 1976 Specification For Ready Mixed Concrete.
- IS 9103 : 1999 Specification For Admixture For Concrete.
- IS 7861 (Part 1) : 1975 Recommended Practice For Extreme Weather Concrete (Hot Weather)
- IS 7861 (Part 2) : 1975 Recommended Practice For

Literature for RCC and PSC

- Design Aids For Reinforced Concrete To IS 456 SP: 16. *BIS Publications*
- Design Of Reinforced Concrete Structures. By N Krishna Raju. *Cbs Publishers & Distributors.*
- Advanced Reinforced Concrete Design. By N Krishna Raju. *Cbs Publishers & Distributors.*
- Prestressed Concrete. By N Krishna Raju. *Tata McGraw Hill Publishing Ltd.*
- Design Of Reinforced Concrete. By Jack C McCormac. *Harper & Row Publishers, Inc.*
- Reinforced Concrete Analysis And Design. By S S Ray. *Blackwell Science Ltd.*
- Limit State Design Of Reinforced Concrete. By P C Verghese. *Prentice-Hall Of India.*
- Advanced Reinforced Concrete Design. By P C Verghese. *Prentice-Hall Of India.*
- Reinforced Concrete. By H J Shah. *Charotar Publishing House.*
- Design Of Prestressed Concrete Structures By T Y Lin & Ned H Burns. *John Willey And Sons, Inc.*

Literature for Steel

- SP 6(1) -1964 Reprint 2001 –Handbook For Structural Engineers. *BIS Publication.*
- SP 6(4) -1964 Reprint 1991 –ISI Handbook For Structural Engineers. Use Of High Strength Friction Grip Bolts. *BIS Publication.*
- Steel Structures. Design And Behavior By Charles G Salmon And John E Johnson. *Harper & ROW Publishers, Inc.*



- Steel Structures. By E H Gaylord C H Gaylord And J E Stallmeyer. *Mcgraw-Hill, Inc.*
- Steel Structures. Controlling Behavior Through Design By Robert Englekirk *John Willey And Sons, Inc.*
- Design Of Steel Structures. By L S Negi. *Tata Mcgow Hill Publishing Ltd.*

Literature for Foundation

- Engineering Code Issued By Ministry Of Indian Railways (Railway Board)
- Hand Book On Soil Engineering For Railway Engineers Issued Ministry Of Indian (RDSO)
- Foundation Analysis And Design. By J E Bowles. *Mcgraw-Hill, Inc.*
- Geotchnical Earthquake Engineering By Steven L Kramer. *Prentice-Hall Of India.*
- Pile Design And Construction Practice By M J Tomlinson. T..

26.2 Rolling Stock

- Bureau of Indian Standards (BIS)
- Indian Railway Standards (IRS)
- Research, Design & Standards Organization Specification (RDSO-spec)
- British Standards Specifications (BS)
- UIC, ASTM, IEEE, IEC

26.3 Electrical

Traction Power System

- IEC 60044 Current Transformers
- IEC 60076 Power Transformers
- IEC 60186 Voltage Transformers
- IEC 60296 Specification for unused and reclaimed Mineral Insulating Oils for Transformers and Switchgear
- IEC 60137 Insulated Bushing for Alternating Voltages above 1000V
- IEC 60529 Degree of Protection provided by Enclosures
- IEC 60056 High Voltage Alternating Current Circuit Breakers
- IEC 60060 High Voltage Test Techniques
- IEC 60071 Insulation Co-ordination
- IEC 60129 Alternating Current Disconnectors and Earthing Switches
- IEC 60255 Electrical Relays
- IEC 60265 High Voltage Switches
- IEC 60298 High Voltage A.C. Metal-Enclosed Switchgear
- IEC 60376 Specification and Acceptance of Sulphur Hexafluoride
- IEC 60688 Electrical Measuring Transducers
- IEC 60694 Common Specification for High Voltage Switchgear and Controgear
- IEC 61634 Use and Handling of SF6 in HV Switchgear
- IEC 60502 Power Cables with Extruded Insulation and their Accessories for Rated Voltage from 1kV up to 30kV
- IEEE Std. 80 IEEE Guide for Safety in AC Substation Grounding
- EN 50122-1 Protective Provisions Relating to Electrical Safety and Earthing

Overhead Line General

- IEC 60050-811 Electric Traction
- IEC 60913 Electric traction Overhead Lines
- IEC 60099-4 Metal Oxide Surge Arresters



OHL Wires

- BS 23 Specification for Copper and Copper-Cadmium Trolley and Contact Wire for Electric Traction
- BS 7884 Specification for Copper and Copper Cadmium Stranded Conductors for Overhead Electric Traction and Power
- DIN 43148 Flexible Cables for Overhead Equipment and Return Current
- DIN 48201 Part 1 Copper Stranded Conductors
- DIN 48201 Part 2 Bronze Stranded Conductors
- EN 50149 Copper and Copper Alloy Grooved Contact Wire
- IEC 60494 Rules for Pantograph of Electric Rolling Stock
- UIC 606-1 Application of Kinematic Gauges to Contact Lines
- UIC 606-2 Installation of 25kV Contact Lines

Insulator

- IEC 60060 High Voltage Test Techniques
- IEC 60071 Insulation Co-ordination
- IEC 60305 Insulators for Overhead Lines with a Nominal Voltage above 1000V- Ceramic or Glass Insulator Units for a.c. System
- IEC 60383 Insulators of Overhead Lines with a Nominal Voltage above 1000V
- IEC 60433 Characteristics of String Insulator Units of Long Rod Type
- IEC/TR 60797 Residual Strength of String Insulator Units of Glass or Ceramic Material for Overhead Lines
- IEC 60672 Ceramic and Glass Insulating Materials
- IEC 60815 Guide for the Selection of Insulators in respect of Polluted Conditions

Isolator

- IEC 60129 Alternating Current Disconnectors and Earthing Switches

Mast

- BS 4 Structural Steel Sections – Specification for Hot Rolled Sections
- BS 449 Specification for use of Structural Steel in Building
- BS 729 Specification for Hot Dip Galvanized Coatings on iron and Steel Articles
- BS 4848 Specification for Hot Rolled Structural Steel Sections
- BS 5493 Code of Practice for Protective Coating of Iron and Steel Structures against Corrosion
- BS 8100 Lattice Towers and Masts

Electrical Services

- IEC 60364 Electrical Installations of Buildings
- BS 7671 Requirements for Electrical Installations
- IEC 60439 Specification for Low Voltage Switchgear and Control gear Assemblies
- IEC 60947 Specification for Low Voltage Switchgear and Control gear
- IEC 62040 Specification for Uninterruptible Power System
- BS 5655 Lifts and Services Lifts
- BS EN 115 Safety Rules for the Construction and Installation of Escalators and Passenger Conveyors
- BS 5000 Rotating Electrical Machines

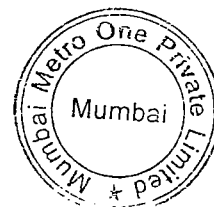

26.4 Automatic Fare Collection

- Fire Safety (Fixed Guideway) - American National Standards, National Fire Protection Association (NFPA)
- Magnetic properties - High Coercivity Ticket Specification
- Contactless Smart Card/Token - ISO 14443 Type A, Type B or Type C
- Ticket/Card – ISO 7816
- AFC LAN – IEEE 802.3 CSMA/CD

26.5 Communication Systems

CCTV

- ITU-R 624-4 Characteristic of TV system
- ITU-R 451-2 transmission of TV signal
- H.264/ MPEG 4 part 10 – Advance video coding

Fiber Optic Transmission

- ITU-T G.652 trackside fiber
- ITU-T G.651 station fiber
- ITU-T G.703, 704 transmission characteristics and sync. frame structure
- ITU-T G.783 SDH characteristics
- IEEE 802.3 – Ethernet LAN
- EIA RS 232/422/485 – serial interface

Master Clock

- ITU - G.811, 812, 813 clock synchronization
- RFC 1305 (network time protocol)

Public Address

- BS EN 60849 – speech quality

Telephone

- ISDN PRI, BRI interface
- E1, T1 interface
- G.712, 713 2W/4W VF E&M interface
- ITU-T I.431, I.441, CCS signalling interface
- ITU-T Q.23 DTMF tone dialing
- RJ-11 plug

Radio

- Local telecom authority's regulations
- EIA/TIA/IS-55 – minimum performance standard for 800MHz dual mode mobile station
- ETSI 300-392, TETRA, Voice plus data Specification

26.6 Signaling

- BRB/LU LTD/RIA Specification No 23: 1992 Version
Technical 2.0b "Safety Related Software for the Railway (Signalling)



- BS 1224 Electroplated Coatings of Nickel and Chromium
- BS 1376 Colours of Light Signals
- BS 4568 Steel Conduit and Fittings for Electrical Wiring
- BS 3382 Electroplated Coatings on Threaded Components Part 1 : Cadmium on Steel Components
- BS 376 part 1 Railway Signalling Symbols
Part 1 : Schematic Symbols (PD 1271)
- BS 3900 Methods of Test for Paints
- BS 729 Hot Dip Galvanized Coatings on Iron and Steel Articles
- BS 729 Part 1 Quality Requirements for Welding Fusion Welding of Metallic Materials
Part 1 : Guidelines for Selection and Use
- BS469 1995 Railway Signalling Lamps
- EN 50081-1 EMC Generic Emission Standard - Pt. 1
Residential, Domestic & Light Industry
- EN 50082-2 EMC Generic Immunity Standard - Pt. 2
Industrial Environment
- EN 50121-2 Railway applications - Electromagnetic compatibility Part 2 :Emission of the whole railway system to the outside world
- EN 55014-2 EMC Requirements for Household Appliances, Electric Tools and Small Apparatus Part 2
Immunity-Product Family
- EN 55022 Limits and Methods of Measurement of Radiated Disturbance Characteristics of Information Technology Equipment
- EN 55024 Information Technology Equipment – Immunity Characteristics – Limits and Methods of Measurement
- EN 60439 Part 1 1994 Amd 3 Low-Voltage Switchgear and Controlgear Assemblies
Part 1 : Specification for Type-Tested and Partially Type-Tested Assemblies
- EN50061 EMC Standard for Cardiac Pacemaker
- ENV 50121-3-2 Railway Applications – EMC Part 3.2: Rolling Stock - Apparatus
- ENV 50121-4 Railway Applications – EMC Part 4:
Emission and Immunity of the Signalling and Telecommunications Apparatus
- IEC 61000-4-1 Testing and Measurement Techniques Section 1:
Overview of Immunity Tests
- IEC 61000-4-2 Testing and Measurement Techniques Section 2:
Electrostatic Discharge Immunity Test
- IEC 61000-4-3 Testing and Measurement Techniques Section 3:
Radiated, Radio-Frequency, Electromagnetic Field Immunity Test
- IEC 61000-4-4 Testing and Measurement Techniques Section 4:
Electrical Fast Transient/Burst Immunity Test
- IEC 61000-4-5 Testing and Measurement Techniques Section 5:
Surge Immunity Test



- IEC 61000-4-6 Part 4, Testing and Measurement Techniques Section 6:
Immunity to Conducted Disturbances, Induced by Radio-Frequency Fields
- IEC 61000-4-8 Testing and Measurement Techniques Section 8:
Power Frequency Magnetic Field Immunity Test
- IEC 61000-4-11 Testing and Measurement Techniques Section 11:
Voltage Dips, Short Interruption and Voltage Variations Immunity Test
- IEC 529 Degrees of Protection Provided by Enclosures
(IP Code) S Second Edition
- IEC 61373 Railway Applications – Rolling Stock Equipment – Shock and Vibration Tests
- MIL-HDBK-217F Military handbook 217F : reliability prediction
of electronic equipment
- prEN50128 Railway Applications: Software for Railway
Control and Protection Systems
- prEN50129 Railway Applications: Safety related electronic
systems for signalling
- RIA 12 General specification for protection of traction
& rolling stock electronic equipment from
transients & surges in DC control systems
- RIA 13 General specification for electronic equipment
used on traction and rolling stock
- RIA 18 General specification for interference testing
for electronic equipment used on traction and
rolling stock
- RIA 22 Technical guide on EMC for electronic
equipment used on traction and rolling stock



PART B

**VOLUME II OF RFP
PERFORMANCE SPECIFICATIONS
FOR
VERSOVA ANDHERI GHATKOPAR MRTS**



TECHNICAL & PERFORMANCE SPECIFICATIONS

TABLE OF CONTENTS

Sr. No.		Page No
1.0	TECHNICAL & PERFORMANCE SPECIFICATIONS	1
2.0	SALIENT FEATURES OF TECHNICAL & PERFORMANCE SPECIFICATIONS	2
3.0	ALIGNMENT	7
4.0	WAY STRUCTURE	9
5.0	STATION BUILDING	11
6.0	ROLLING STOCK	12
7.0	TRACTION SYSTEM – OVERHEAD EQUIPMENT	20
8.0	THE FACILITIES	23
9.0	SIGNALLING SYSTEM	24
10.0	PASSENGER INFORMATION SYSTEM	26
11.0	INTERLOCKING SYSTEM	27
12.0	COMMUNICATION	27
13.0	DIGITAL ELECTRONIC EXCHANGE NETWORK	28
14.0	TICKETING AND FARE COLLECTION	28
15.0	COMMISSIONING OF SYSTEM	29
16.0	OPERATION & MAINTENANCE	32
17.0	MAINTENANCE MANUALS	33
18.0	MISCELLANEOUS	34



1.0 TECHNICAL & PERFORMANCE SPECIFICATIONS

1.1 PREAMBLE

The aim of this document is to define the system performance requirements for the proposed MRT on Versova-Andheri-Ghatkopar corridor in Mumbai.

• General

In the absence of any definite provisions on any particular issue related to the specifications and/ or standards, reference may be made to the latest codes and specifications of Indian Railways, the Bureau of Indian Standards (BIS) or any other international standards in that order of precedence. Where these are silent, the construction and completion of the works shall conform to sound Engineering practice with the approval of MMRDA Consultant / Designated Engineer.

• Specifications

"Specifications" here in under mean the specifications relating to the quality and performance requirements for the MRTS Project as set forth in this volume and any modifications thereof, or additions thereto, as included in the design by the Designated Engineer to the MRTS Project submitted by the Concessionaire to MMRDA at the time of Bid and expressly approved by MMRDA.

Where standard specifications are silent, the Concessionaire shall obtain the approval of the MMRDA Consultant/Designated Engineer for the specifications for the material in question prior to its incorporation in the work.

2.0 SALIENT FEATURES OF TECHNICAL AND PERFORMANCE SPECIFICATIONS

2.1 General:

- No Codes of Practice are available in India which are specific to the requirements of rail based Mass Rapid Transit System (MRTS) of similar nature.
- Indian Railways have detailed technical specifications and standard practices as contained in the relevant Codes of Practice and Manuals covering various aspects of rail based system mainly for Broad Gauge (1676 mm) and Meter Gauge (1000 mm) including suburban system. No specifications are available for Standard Gauge (1435 mm). Indian Railway's Codes of Practice will however, be followed to the extent applicable.
- The technical specifications adopted for Delhi Metro elevated portion are also proposed to be followed for design and construction of Versova-Andheri-Ghatkopar MRTS.
- Where the available National Codes are silent, reference should be made to the International Codes of Practice and / or good industry practices.
- For preliminary designs, bidders may adopt the provisions of various Indian/ International Codes to the extent applicable. At the detailed design and procurement stage, specifications may undergo some changes.
- The MRTS should be designed generally to satisfy the performance specifications.
- To optimize the overall project cost including O & M expenditure, bidder will have the flexibility of designing various components of the MRTS, provided major performance



specifications are satisfied and safety and comfort of the commuters is not affected adversely.

- No change in mandatory requirement will however, be acceptable. Mandatory items are - corridor alignment, location of stations, system gauge, quality of service, car shed location, accessibility to physically challenged people, coach air-conditioning, electric traction, etc.
- The bidder must submit complete list of various standards and specifications adopted in preparation of bid, highlighting important features.

2.2 Major Requirements:

From the point of view of system performance specification, the major requirements of the system are that it should be:

- Safe
- Reliable
- Quiet
- Attractive
- Efficient
- Comfortable
- Accessible to physically challenged people

To achieve the above, a creative overall approach based on the best current proven technology, design, planning and operating practices is required in order to:

- Handle the passenger demand efficiently.
- Minimize impact on road users and pedestrians
- Minimize visual intrusion and noise pollution, particularly in environmentally sensitive areas

2.3 Operations:

The bidder will make his own assessment of the travel demand and design the system operational characteristics to satisfy the demand up to the end of the concession period i.e. 35 years from the date of the signing of the Concession Agreement. Long term expandability be also kept in mind.

2.3.1 Hours of Operation:

The operator of the MRTS will need to provide services at least between 05.00 hours (departure of the first trains in service from the terminal stations) and about 01.30 hours (arrival of the last trains in service at the terminal stations).

2.3.2 Waiting time & Passenger Density:

The peak period on this section is expected to be between 08.00 to 13.00 and 17.00 to 22.00 hours.

The peak service frequency shall be such that it will ensure that the predicted passenger flow can be carried with safety and comfort. During peak period the average waiting time shall not exceed 3 minutes. During off-peak and low time periods service frequencies will be such that average waiting period does not exceed 6 minutes.

At least 10% of passengers of the coach capacity shall be able to travel seated. When calculating the maximum standing capacity, a passenger density of 8 passengers per square meter shall be assumed.



2.3.3 Average Scheduled speed/journey time:

Average scheduled speed of trains on Versova – Andheri – Ghatkopar Section with 10 intermediate stations shall not be less than 33 kmph). The journey time between Versova and Ghatkopar shall not exceed 21 minutes including halt/ dwell time.

2.3.4 Provision of future growth:

Account shall be taken in the design of all parts of the system – particularly the stations, power supply system, depot, control and information facilities – of possible future increase in service levels and number of vehicles. The system shall be capable of providing increased service levels to respond to growth in passenger demand at-least up to the end of concession period. Provision should be made for inducting additional rakes at the appropriate stage.

2.3.5 Reliability:

All equipment shall be designed to optimize reliability and to minimize the input in manpower and material required to maintain a safe and efficient service. The provision of spare equipment shall be such as will ensure safe and efficient operation of the system to satisfy the specified service standards.

2.3.6 Minimizing Life Cycle Costs:

Total capital and operating costs shall be minimized by such measures as:

- Using high performance and high capacity trains to minimize the number of train units and crews for a given passenger demand,
- Optimizing the train weight, performance and power supply parameters to reduce the installed power and energy requirements,
- Using the maximum number of proven standard components to reduce first cost and spares' holding.
- Minimizing rolling stock maintenance costs by the use of fault diagnostics, easily replaceable components, and by paying special attention to minimizing wheel and rail wear,
- And by other appropriate measures.

2.3.7 Design Life:

Whilst it is recognized that the design life of equipment will vary, the overall design of the system should be such as would ensure that all equipment will be capable of continued operation for a period of three to five years after the termination of the concession. Elements of the system, whose normal design life may not satisfy this requirement, should be planned for replacement/renewals during the concession period. Minimum residual life of all assets at transfer should be 3 to 5 years.

2.3.8 Visual Intrusion:

Particular importance shall be attached to minimizing the overall intrusion of the system by landscaping of the elevated structure and by careful attention to the station design.

2.3.9 Access for Physically challenged persons:

The system requirement includes that MRT System has to be "accessible to the physically challenged". In consequence, all stations will be equipped with lifts in addition to elevators linking the platforms with the road level.

2.3.10 Safety, Security & Reliability:



- **Safe Movement:**
In the design of stations, vehicles and monitoring equipment, particular care shall be taken to ensure safety in station accesses and exits – while passengers are waiting, boarding and alighting – and in moving vehicles. Appropriate facilities shall be provided to ensure safe and efficient evacuation from vehicles in case of emergency.
- **System Integrity:**
In the design of power supply, signaling, track- work and vehicle, circuits and equipment, particular care shall be taken to minimize the likely incidence of failure.
- **Restoration of Service:**
The system shall be designed so that, where a fault occurs, a limited service can be provided within a few minutes by isolation of the affected area or equipment, to the extent possible.
- **Safety Management:**
Safety is of paramount importance. A safety statement shall be prepared bringing out clearly the system of checks, maintenance tolerances for various assets – rolling stock, track and signaling - staff training and awareness and handling of emergencies etc. Current worldwide experience and practices for similar MRTS system shall be referred to. Accident free system is the desired goal. The detailed Manuals for all disciplines will have to be prepared for operation and maintenance by the concessionaire before opening the system for carriage of passengers
- **Safety equipment:**
The following equipment shall be available at every MRTS station:
 - Fire extinguishers and fire alarms at the appropriate locations on the platforms
 - Two fire extinguishers in the station office
 - A stretcher and at least one standard first aid box in the station office
- **Security:**
Safety and security of the MRT system are very important. Specific arrangements are necessary where dense passenger concentration takes place in the trains, on the platforms and at the accesses to the stations by manning by trained security personnel. A set of emergency procedures shall have to be formulated to deal with different emergency situations. Operations staff will be trained to respond during emergency involving the transit system through periodic simulated exercises as laid down in Disaster Management Manual (To be prepared by the Concessionaire).
- **Fire Safety:**
In case of a fire in MRT system:
 - Human life is endangered,
 - Material damage with accompanying high costs results.
 The organizational measures, in order of priority, are necessary to:
 - Save lives,
 - Fight the fire and limit material damage as much as possible.
 To prevent fire in the passenger areas, it would be desirable to use only fire resistant materials in their construction. The use of materials which are to some extent flammable, or which emit smoke and harmful gases when burning, is to be avoided. The selection of materials must be decided by the following factors, in order of priority:
 - Select fire resistant materials
 - Select materials which have the smallest specific toxicity



- The limitation of fire damage by smoke gases has the highest priority.
- In case of fire occurring in the coaches traveling on the line, the same should be cleared quickly. Special areas of attention are:
- In cases of fire, there should be escape route available.
 - Escape path not less than 0.70 m wide should be provided. The path should be no more than 0.4 m lower than the floor of the vehicle.
 - Emergency exits should be accessible without any obstructions. Exit doors should be permanently locked but easily to be opened from inside.
 - Escape routes must be clearly marked by arrows in the correct direction. No cryptic symbols should be used, and the possibility of poor visibility because of smoke should be taken into account. If possible, notices should be standardized.
 - Passengers should not be endangered by continued operation on adjacent tracks.
- It will be essential to adopt rescue and fire fighting plan and include the same in the Disaster Management Plan and train the concerned personnel in the respective fields.

2.3.11 Passenger Security and Information System:

- The passenger security and information system would manage the MRTS passenger related functions. It shall provide the Operation Control Centre (OCC) with the facilities to supervise the passenger areas and trains, to provide visual information to passengers both onboard and to provide one way communication from Operation Control Centre to the passengers at stations through Public Announcement (PA) system.
- The passenger security system comprises a Closed Circuit Television (CCTV) System monitoring the stations and emergency call points on the stations.
- The passenger information system comprises dynamic visual displays and loudspeakers.
- In order to achieve the objectives, the locations and certain requirements for CCTV cameras, loudspeakers, and information displays have to be determined as part of the architectural design process during the basic design of the stations.

2.3.12 Climatic Conditions:

All systems and equipment to be used for this project should be designed, manufactured and installed taking into account the local climatic conditions.

3.0 ALIGNMENT:

- The proposed alignment starts at Versova near Seven Bungalows and runs on elevated structure all along the proposed median of Jai Prakash Road. It crosses the S.V.Road and Western Railway tracks over elevated structure to the north of the existing Andheri Suburban Railway Station. After crossing the Western Railway tracks, the alignment travels on the median of M.V. Road. It crosses the Western Express Highway (W.E.H.) on elevated structure and eventually reaches Asalpha. From Asalpha, the alignment passes along the D.P.Road and Golibar Road. After crossing the L.B.S. Marg, the alignment passes along H.D. Road up-to Ghatkopar MRTS Station proposed over the Central Railway tracks.
- The branch line to the Airport takes off at Airport Road Station, runs on the elevated structure along the Airport Road up-to the Terminal Station at Sahar Airport.
- The take off point for car depot is located at D.N. Nagar station.



- The details of the horizontal curves may be seen in the detailed alignment plan. Sharpest curve is of 100 m. radius.
- Horizontal curves will be designed for maximum comfort and safety. The super elevation and cant deficiency should not be more than 150 mm and 100 mm. respectively. The curve design in general should be in accordance with Indian Railways' practice or International practice for similar MRT System.
- No change in alignment and station location except for minor variation if so needed during execution is permitted.
- The alignment crosses the Western Express Highway above the existing flyover. This location will require longer span of 45 m. or so. Minimum clearance above road level of flyover should be 5.5 m.

3.1 Vertical Alignment:

- L – Section for the corridor may be seen in the Drawing Volume. Entire alignment from Versova to Ghatkopar and Airport Station is on the elevated structures.
- The vertical curves are required to be provided at locations with change of gradient more than 4 mm/m i.e. 0.4%. The radius of vertical curves should be not less than 1000 m.
- The steepest gradient is 4%.
- The main alignment parameters are as under:-

(i)	Track Gauge	1,435 mm
(ii)	Maximum operational speed	80 km / hour
(iii)	Minimum radius of curvature	100 meters
(iv)	Maximum gradient	4%

4.0 WAY STRUCTURE:

- The way structure should be designed for an Axle Load of 18 tonnes. The train configuration should be same as proposed to carry the projected peak hour traffic.
- Other loads and forces to be considered for design should be in accordance with the proposed rolling stock's technical characteristics. Reference can be made to Bridge Rules of Indian Railways for guidance to the extent applicable.
- Continuous welded rails are proposed to be used for the ballast-less track structure. The rail temperatures are expected to be in the range of 51° to 60° Celsius. The resultant forces must be considered in the design of the structure.
- The material of construction for the way structure will be R.C.C./Pre-stressed concrete. The Indian Railway's Concrete Bridge Code should be followed.
- Bidders can propose use of composite construction if considered an economic alternative and it generally satisfies all other structural requirements.
- Either a Box Section or 'U' Section or any other efficient structural form can be adopted for the main spans. Design must provide for suitably designed sound barriers all along the corridor.
- The way structure is proposed to be supported on a single column erected mostly along median of the road. At few locations it would be necessary to adopt portal frame support in lieu of single column, mainly where alignment of MRT does not coincide with road median.
- The geo-technical investigation along the corridor indicates use of the pile foundation. The sub – structure should be designed in accordance with Indian Railways Sub-structure



and Foundation Code. The relevant Indian Standard Code may also be referred to as required.

- The width of the way structure shall be 8.95 m. with track centre at 4.05 m.
- The minimum clearance above the road level shall be 5.5 m. The clearance above the rail level where the alignment crosses the existing railway tracks shall be in accordance with the Schedule of Dimensions of Indian Railways as applicable for 25 KV AC traction and should generally be not be less than 6.55 m.
- A passage of adequate width (not less than 700 mm) all along the corridor is required to be provided to facilitate evacuation of commuters during emergency.
- Ducts for laying electrical signal and communication cables should be provided.
- Adequate drainage should be provided for the way structure and connected suitably to the underground drainage. The average annual rain fall in the area is approximately 2000 mm. The rain fall intensity is as high as 75 mm. / hour.
- For construction of the way structure, use of pre-cast elements to the maximum possible extent appears to be the necessity in view of the corridor being heavily congested. This fact must be kept in mind while designing the structure as a whole.
- The structure should be aesthetically pleasant.
- No piers should be located in front of religious sites.
- A typical cross section of the way structure may be seen in the Feasibility Report. The structural dimensions are for a typical 25 m. span.

4.1 Track Structure:

- The track over the elevated structure will be the ballast-less track for ease of maintenance and good running quality.
- The ballast-less track shall be designed following the best international practice. The track structure proposed should be easy to lay and maintain. The life cycle cost should be optimum keeping safety and comfort of commuters in view. The noise level should be within permissible limits as laid down in the ambient noise standards of Central Pollution Control Board (CPCB), for industrial and residential areas.
- 60 Kg. rail sections should preferably be used, conforming to IRS/UIC specifications.
- Rails can be welded using A.T. welding as per Indian Railways' specifications or by any other standard method of welding.
- The track at grade shall be conventional ballasted track laid on 250 mm thick ballast bed with 1540 PSC sleepers / km. and 60 kg. IRS / UIC rail fixed with elastic fasteners. The rails can be welded into suitable lengths.
- The track structure in the car shed area will be similar to track at- grade in general except that the rail section can be of 52 kg.
- The laying of welded rails shall be in accordance with the Indian Railway Manuals to the extent applicable.
- 60 kg, 1 in 10/1 in 12 Turnouts will be provided for stations as per approved layout.
- The standard gauge turnout design will have to be provided by the Concessionaire and approved by the Designated Engineer
- For the car shed area 52 kg, 1 in 6 / 1 in 8^{1/2} turn outs can be provided.
- All turnouts on main line and yard will be operated by point- machines. Indian Railway standards will generally apply.



- The switch expansion joints for the continuous welded tracks will be specially designed and manufactured to suit the temperature range as obtained in the corridor. Expected temperature range is 51° to 60° Celsius.

5.0 STATION BUILDINGS:

- Location of stations is indicated on the alignment plan and no change in location will be permitted, except some minor variations during execution.
- Stations will be designed in accordance with N.B.C. / I.S. Codes and applicable local byelaws. All functional requirements to handle projected traffic for the horizon year must be satisfied.
- The station should be user friendly and fully accessible to physically challenged persons.
- For safety against Fire, provisions of N.B Code and NFPA- 130 norms must be strictly followed. Local fire safety guidelines / regulations will also be followed.
- The structure as a whole must be designed, so that it merges well with its surroundings. The design will be site specific.
- The station layout should provide adequate accommodation for all operating, commercial and managerial requirements.
- Adequate conveniences/amenities for the commuters should be provided as per the projected level of traffic.
- The finishes should be of highest standard and easy to maintain.
- All the equipments for the Stations must be designed as per good industry practices observed by other similar systems internationally.
- The station layout will follow the 'closed' pattern i.e. there will be separate paid and unpaid areas. The stations will be provided with Automatic Fare Collection system and will be fully access - controlled.
- All Stations except Airport Road will have side platforms. The Airport Road Station will have an island platform.
- The length of the platform shall be equal to the length of the train plus the safety margin. Provision for future extension should be made in the design.
- The minimum platform width shall be 3.5 m.
- Escalators shall be provided to all platforms for both way movements.
- At least one lift per platform will be provided for the use of physically challenged persons.
- The stations will be provided with concourse at intermediate level and roof covering the entire station including tracks. No commercial activity is to be permitted on the platform. The concourse area can, however, have some commercial stalls for commuters' facilities.
- Ghatkopar MRT Station is proposed to be located across busy Central Railway suburban section. The vertical and horizontal clearances should be in accordance with the Schedule of Dimension of Indian Railways applicable for 25 KV AC traction.
- Exit and Entrance doors shall be suitable for the maximum number of passengers passing in any 15 min. peak period. For emergency evacuation of a train, provision shall be made to clear the platform in 4 min. To do this, a crush capacity of 25 passengers per minute per foot width of passageways, 20 passengers per minute per foot width of stairways may be assumed.
- A typical station layout may be seen in the Drawing Volume.

6.0 ROLLING STOCK:



6.1 General:

The MRTS Rolling stock shall have the following characteristics.

- A safe, reliable, user-friendly and attractive vehicle, with capacity to meet the specified demands and good riding qualities.
- Easy access for physically challenged people.
- High performance, to meet the limiting gradients and curves in both normal and emergency operation, while optimizing the balance between journey time, total number of vehicles and crew, energy consumption, power supply, traction equipment and motored axles.
- High availability of not less than 97% with low maintenance costs over a life cycle, low wheel wear, minimum servicing and short down time, based on good diagnostics and minimum component replacement time.
- Ease of exterior and interior cleaning, with low labour content, and absence of dirt and dust traps
- Special features of noise reduction
- Fire hazard – proven non-inflammable, self extinguishing material to be used.
- Light weight – design shall achieve minimum weight consistent with safety and reliability
- Quick reversibility at terminal
- Attractive interior finishes of appropriate fire resistance standards, which age well and do not date
- Optimizing the Mean Time Between Failures (MTBF)

6.2 Basic Dimensions

- The basic dimensions of the car should be based on the following considerations.
- The maximum number of passengers to be carried per 4 car rake has been put at 1500
- Maximum car width – 3.2 m.
- The car should be pleasant to the traveling public and should not give a feeling of congestion or suffocation.
- Longitudinal seats would be provided for convenience and better accommodation.
- The ratio of standing to sitting passengers will be between 5-7:1
- The door opening on each side will be between 25% and 35% of the length of the car.
- Occupation density in the standing areas under dense crush load will be 8 persons per sq.m. and 6 persons per sq.m under normal loading condition.
- Vestibulating arrangement should be provided in every car.
- Only one class of accommodation would be provided.
- The recommended approximate dimensions of the car are as under –

Length (buffer to buffer)	22 m
Width (outer to outer)	3.2 m (maximum)
Height from rail level to the topmost part of the empty car	3.60 m
Height from rail level to floor level of empty car with new wheel	1.05 m
Height of platform from rail level	1.00 m



On the basis of the design considerations indicated above, a car of this dimension will be able to carry about 300 passengers under crush load condition and 375 under dense crush load conditions of which 40 would be seated passengers.

**The dimensions given above are only recommendatory in nature. The bidder can optimize overall size to satisfy basic requirements.

6.3 Performance Parameters:

The design of the vehicle shall satisfy the following performance parameters.

- Design speed - 80 kmph
- Maximum Acceleration - 1.1 m/sec/sec
- Jerk Rate/Rate of change of acceleration - 0.8m/sec/sec/sec
- Maximum Deceleration (normal) - 1.2 m/sec/sec
- (emergency) 1.4 m/sec/sec
- Minimum radius of the curve (should be capable of negotiating) - 100 meters
- Steepest gradient - 4%

6.4 Car Body:

The car body should be of modern light weight construction, consistent with strength and safety requirement. The coach should be aesthetically pleasant and functionally sound. Stainless steel body will be preferred.

- **Doors:**

The ratio of the door opening length to the length of the car shall be 0.25 to ensure discharge and entry of the passengers within 20/30 seconds, the dwell time provided for.

The doors may be power-operated- pneumatic or electric- and their opening and closing will be controlled from the drivers' cab for reasons of safety. Interlocking will be provided between the doors and the traction control.

- **Windows:**

Windows should be as wide as structurally feasible. This will facilitate reading of the station names and will be aesthetically pleasing. Windows will be double glazed and of fixed type. For reasons of safety the glass will have to be shatterproof.

- **Car Profile:**

The sides should be kept near vertical to permit easy washing with car washing machines. The front of the cars has to be profiled to a shape which, within reasonable costs, will result in lower aerodynamic resistance.

- **Vehicle Interior:**

- All coaches shall be air conditioned with internal ambient temperature of 24^o Celsius
- All coaches would be vestibuled

- **Access for passengers with Impaired Mobility / physically challenged people:**

All vehicles shall be fitted out to satisfy the relevant codes and standards. In addition, all passenger doors on each side of each vehicle shall be level + 25 mm at all conditions of car loading with the edge of a trackside platform. The gap between the platform edges



shall be minimized but shall not exceed 75 mm. Safe areas clear of doors and gangways shall be provided for wheelchairs.

- **Vestibules:**
Coaches will be suitably vestibule for proper distribution of commuters and emergency evacuation, if needed.
- **Driving Cabin:**
 - The driving cabs will have to be provided at both ends for ease of reversal at terminal stations.
 - The size of the car should be adequate to accommodate all the control equipment.
 - It should be kept in mind that cab signaling / automatic train operation may be necessary at a later date, if traffic so demands.
 - The cab layout should be ergonomically satisfactory so as to put least strain on the driver.
 - Cabs should have a front door of adequate width to permit frontal evacuation during emergencies, if necessary

6.5 Anti-noise Measures:

- **Within coaches**
Measures have to be taken to avoid incidence of noise in the cars. By use of suitable materials, the interior of the car bodies should be provided with acoustic insulation. Suitable insulating materials should be interposed in the car floor to prevent ingress of noise from the under-frame and the bogie. Sound and shock absorbing type of mountings should be used for mounting the equipment. Again, all equipment has to be so designed as to produce least noise. Ultimately, it has to be ensured that the noise level inside the cars while running does not exceed 75 dB.
- **Outside Coaches:-**
Most noise in a moving train on steel rail is generated in wheel – rail contact area, which is transmitted inside coaches and in surrounding areas. The track structure should be designed with adequate resilience to minimum noise.
 - Use of pneumatic suspension also reduces the noise to some extent and that leads to an attenuation of outside noise and is recommended for adoption.

6.6 Train Composition:

6.6.1 Bogie, Wheel, Car Suspension and Coupler

- **Bogie:**
The bogie design should permit the curve of 100 m radius being negotiated safely with least strain on the track structure.
- **Wheel and Axle:**
Solid wheels which are economic and lighter are recommended. The main axle box will be fitted with roller bearing.
- **Car Suspension:**
Cars should have interleaved rubber and pneumatic suspension due to following considerations –



- 1) Reduction of overall weight and maintenance cost as also reduction of incidence of noise;
- 2) Achievement of improved non-linear stiffness characteristics by the use of interleaved rubber springs.
- 3) Ability of the pneumatic suspensions in maintaining constant car floor height under all loading conditions;
- 4) Better riding qualities of the vehicles provided with pneumatic suspension arising out of the latter's ability to maintain constant static deflection.

- **Coupler:**

For flexibility of operation, it is proposed to use automatic Scharffenberger type center couplers designed for buffing load of 100 tonnes.

6.6.2 Propulsion System:

- **Traction Motors**

Three phase AC traction motors of latest design are proposed to be used. All the 4 axles of the motor coach will have motors. The combination of motor and trailer coaches can be optimized to achieve performance specifications and least energy consumption.

- **System of control for Traction and Electrical Braking:**

Properly designed VVVF controls will be provided using state of the art GTO/IGBT technology.

- **Braking System:**

Each car should be provided with the following braking systems viz. (1) Electro dynamic brake, (2) Electro-pneumatic brake, (3) Direct pneumatic brake, and (4) Parking brake. Electro-dynamic brakes will be equipped with regenerative capacity.

6.6.3 Miscellaneous Equipments in the car:

- **Signaling and Communication:**

The cars will be provided signaling and communication equipments as detailed below:

- Public address system for the train crew to make various announcements to the passengers like station names, emergencies etc. Central Control should also be able to make announcements on the same.
- Radio communication between driving cab and the central traffic control; and
- Telephone communication between the front driving cab and the rear driving cab.
- Bell code system between front and rear cab.

- **Auxiliaries:**

The main machines will be (1) compressor for supplying compressed air for electro-pneumatic braking and door operations etc. (2) battery charger for charging the battery which will supply the control circuits, communication circuits and emergency lights; and (3) power source for operation of lights and ventilating fans. These auxiliaries will be fed by 415 V 3 phase 50 c/s AC. This will permit use of standard equipments.

- **Lighting:**

Car lighting will be done by 240 V AC fluorescent lamps of recessed type. At floor level the intensity of illumination will be kept at 100 lux. Emergency incandescent lights from



110 V battery will be provided for skeleton lighting in the cars as also for the head lights and marker lights.

- **Portable Equipments:**

Each driving compartment will contain fire extinguisher, first-aid box and a portable light assembly.

- **Coach Air Conditioning:**

To improve the comfort of the passengers the coaches will be air-conditioned. Air conditioning will be provided with roof mounted air-conditioning units and ducting fixed to the roof of the coach. These air-conditioning units will be run on battery, which will be housed underneath the coach. Battery will be charged by battery charger, which will draw power from OHE. The air will be let out into the coach at 22^o C at grill level. The temperature inside the coach will be slightly higher because of frequent opening and closing of coach doors at every station at an approximate time interval of 2 to 3 minutes. This temperature control will create adequate comfort condition for the passengers traveling by MRTS.

Due to air conditioning of coaches the windows will be sealed and air- tight to create a dust free atmosphere inside the coach, which will further increase the comfort level of the passengers.

- **Displays, Announcements:**

Multi lingual displays indicating the next stopping station shall be fitted in all coaches such that all passengers may easily distinguish them. An audible warning will be given immediately before the closing of all passenger doors. All train-units shall be fitted with a radio communication with the Operation Control Centre. All train-units shall be fitted with a driver to passenger communication system.

- **Station Signage:**

All clear directional, informative, instructive and warning signs shall be provided to international standards and route map displays shall be provided inside the coaches.

- **Mechanical and Technical Details:**

All mechanical and electrical systems shall satisfy the requirements of appropriate codes and standards. The standards adopted shall be clearly indicated.

All handgrips, push buttons and exposes metal parts, which may come into contact with passengers, shall be insulated or earthed in accordance with the regulations in vogue. Headlights, sidelight and safety guards shall be of such designs as will satisfy the relevant regulations and standards.

- **All train units shall:**

- operate with a traction power supply of 25 KV AC
- collect the traction current from OHE by Pantograph fitted on the train
- be capable of negotiating sharpest curves of the alignment
- be capable of ascending and descending all maximum gradients and minimum curve radii fully loaded, in regular service, including stopping and starting
- be capable of running coupled together in multiple-unit trains



- o be capable of fully loaded, of coupling up to, moving and stopping an empty failed train the maximum gradient of the alignment
- o be capable, when fully loaded, of coupling up to, moving and stopping a fully loaded failed train up to the next station
- o be fitted with regenerative and mechanical brakes
- o be designed to minimize noise and vibration.
- o be provided with emergency facilities for disconnecting the train from the traction current supply
- o Comply with all relevant fire specifications
- o be fitted with destination indicators
- o be of such a design and specification as can reasonably be expected to have a routine service life of not less than 30 years.

6.6.4 Transportation of Rolling Stock:

Coaches may be imported or manufactured locally by suitable tie-ups and T.O.T. Non-availability of direct connection will need special action to transport the coaches from manufacturers to the MRTS system viz. D.N. Nagar Car Depot where every coach is to undergo inspection, testing and commissioning before it is inducted into commercial service. The transportation of coaches from manufacturer's premises / port may be by road using special trailers or rail- road combination. Suitable unloading facilities will have to be organized in car shed area.

6.6.5 Indigenous Rolling Stock Manufacture:

Integral Coach Factory (Perambur), Rail Coach Factory, Kaputhala (Punjab), Jessop and Company (Calcutta), Bharat Heavy Electricals Limited (Bhopal) and Bharat Earthmovers Ltd. (Bangalore) are indigenous manufacturers of the rolling stock being supplied to Indian Railways. This is for the information of the bidders.

The technical/performance specifications given above are basically indicative of the basic requirements. The bidders can optimize the design of the rolling stock keeping in view generally the above parameters, so that the projected traffic could be handled efficiently and safely.

7.0 TRACTION SYSTEM – OVERHEAD EQUIPMENT:

The traction system will be 25 KV AC (OHE)-

- The OHE design shall conform to the Indian Railway standards or International Standards or as used for similar MRT systems elsewhere.
- The OHE masts shall be galvanized. The normal span will be 60 M. but can be changed to suit site conditions.
- The OHE shall be designed for the maximum speed of 80 kmph.
- The sizes of the catenary, contact wire, jumpers etc. be designed to suit the operational requirements optimally.

7.1 Power Supply:

- Power supply systems include substations, the OHE and all associated switchgear etc. and shall be designed as a safe and reliable means to supply the electrical power needed to maintain the required system performance.



- The power will be taken from Reliance energy / Tata Power or others at the receiving sub-stations, where it will be stepped down suitably.
- The traction supply system shall be designed on the basis of 25 KVAC OHE. Power supply for traction should be arranged from two different sources to ensure reliability in operation of the MRT System. Supply may be available at 33 KV or higher voltage.
- The number and location of sub-stations would be decided based on the traffic load on the network and location of sections of high power demand (grades, station areas).

Layout of the power supply system particularly shall emphasize the following aspects and criteria:

- Integrity of the traction and auxiliary power supplies, and the ability to restore supplies rapidly or maintain restricted services in the event of partial failure in accordance with strategies for fall-back operation.
- Ability to re-start services as rapidly as possible after a total failure of traction current supply, particularly to absorb a short-term overload caused by a large share of the rolling stock starting within a short period of time.
- Economy in traction energy consumption achieved by regenerative braking consistent with good performance.
- Optimum number and location of sub-stations, with minimum consumption of at grade space to achieve the objectives above.
- Well-designed substation buildings.
- Capacity for future system extension without extensive alteration to the existing power supply systems and service interruption on the existing part of the MRT.
- Switchgear and circuit breakers shall be able to operate on three levels: remote control from OCC, local operation from the substations and manual operation directly on the component.

The power supply system shall be designed for normal operations and contingencies operations. For this the following non-coincidental scenarios shall be used:

- Worst-case train delays and train bunching
- Emergency operation plans and various deviations from the normal service schedules.
- One traction substation failure
- Power feed-back from regenerative braking.
- One utility supply point/interface failure
- Abnormal power supply system configurations caused by planned outages or outright failures of equipment including feeders, circuit breakers, transformers and rectifiers.

7.2 Substations and incoming power feeds:

- Installations shall be safe and efficient and shall be provided with enclosures protecting from climatic and environmental influence, as well as from damage by accidents or vandalism. Space required shall be minimized.



- The equipment shall be designed to minimize the probability of interruptions to the service as a result of a failure of the electricity supply or of the switching and distribution network and to limit touch potentials and stray currents.
- Power feeds from local grid shall be planned on the basis of the highest possible availability and / or redundancy in co-ordination with the supply authority. The traction substations shall transform the incoming high voltage AC Power to 25 KVAC and distribute it to the OHE. The substations will be completely remote controlled and monitored via SCADA.
- The earthing system shall be treated with special care, because of the safety of persons. Absolutely separated earthing systems are required for system equipment and structures / ground potential.
- Auxiliary power supply for lighting of the stations, etc. must be provided from the same system and locally from the supply authority.

7.3 SCADA (Supervisory Control and Data Acquisition) System:

The purpose of the SCADA system is to ensure safe and reliable supervision and control of the infrastructure of the complete MRT system. Supervisory control shall be provided to give an overall picture of the system status at the Operations Control Centre (OCC) and to control the power systems under normal and emergency conditions.

Control of the Traction System shall include emergency trip stations to remove power from the OHE in a traction segment. The trip station switch shall be self-resulting and power shall only be restored by the OCC.

a) Sub Stations

Electric power will be supplied at 25 KV AC.

b) Feeding Stations

Supply will be affected to the overhead equipment through switchgear installed at feeding stations. All feeding stations will be located normally near the track.

c) Sectioning Stations

The sub-stations, as a rule will be paralleled and a neutral section of overhead equipment with insulated overlaps will be provided near the feeding stations. Facilities to bridge the neutral section between feeding stations will be provided at section stations, if provided.

d) Sub-sectioning Stations

In order to facilitate maintenance of overhead equipment and permit isolation of faulty sections and expeditious restoration of power supply in healthy sections, sub-sectioning stations insulated overlaps will be provided between the feeding stations and the sectioning stations, if provided.

Car Depot:

The Car Depot cum Workshop will be located at D.N. Nagar

8.0 THE FACILITIES:

- The stabling lines, inspection lines, repair bays, rake washing lines, test track, covered sheds etc. as shown in the car depot plan are based on certain assumptions regarding



various periodic maintenance schedules and POH etc. The actual schedules will, however, depend on rolling stock finally selected for the operations and technology adopted. The car shed layout can be optimized accordingly considering inter-alia maintenance strategy. The layout will require MMRDA's approval.

- The rolling stock maintenance should be organized to ensure maximum availability, highest reliability, safety and comfort with least life cycle cost.
- The depot should be equipped accordingly. Train washing machines are envisaged for external washing of coaches. List of equipment should be given with the proposal. This may undergo changes during implementation stage.
- The depot will also be provided with all ancillary facilities – water supply, lightening roads / pathways, boundary wall, proper drainage, fire fighting equipment etc.
- Administrative building with OCC, maintenance facilities including accommodation for all disciplines – civil, electrical, S&T, canteen, driver's rest room, staff recreation facilities, first aid etc. are required to be provided.
- The car depot layout must have adequate provision for further expansion to cater to the maintenance needs for the entire concession period and even beyond.
- The land requirement for the depot should be clearly given. MMRDA proposes to acquire 3.4 ha. as per tentative plan.
- If any facility is not listed above, but is considered essential for maintenance, the same should be provided.
- The car depot yard layout will have number of turnouts for placement / withdrawal of rakes to / from various sidings as required for maintenance operations. The yard should be fully interlocked for centralized operation. RRI or panel interlocking as considered economical shall be provided. Solid state interlocking system can be adopted as an alternative to conventional system.
- The system design and all the materials including point machines shall confirm to Indian Railway's specifications and good industry practices.
- The car depot yard will have ballasted track structure similar to track-at-grade except that the rail section can be of 52 kg. Rails can be welded into 3 rail panels.
- The yard will be electrified for all train movements.
- The maintenance sheds will be designed in accordance with IS specifications for industrial structures. The buildings will satisfy all functional and structural requirements as per IS codes, National Building Code, byelaws etc.
- Communication facilities to effectively communicate with yard staff should also be provided.



- Proper yard lighting for night operations is essential pucca pathways for movement of yard staff should be planned.

9.0 SIGNALING SYSTEM:

9.1 Main features:

Three-aspect colour light signaling is proposed for the MRTS. The main requirements are –

- The system shall be safe for trains, traveling passengers and MRTS staff, both in normal and emergency operation. It shall enable rapid and safe recovery from interruptions.
- The system, in an unlikely event of failure shall fail towards the safe side.
- The signaling system shall be able to meet requirements of the train density forecasts in time period under consideration.
- It shall be possible to operate entire signaling system from Operating Control Centre (OCC). At OCC it shall be feasible to monitor the entire system with the help of mimic diagrams that shall enable to supervise the entire section between Versova – Andheri – Ghatkopar. The OCC shall be able to direct and control the maintenance staff also.

All signaling equipment shall be designed to:

- Minimize failures,
- Prevent wrong side failures,
- Be capable of easy repair,
- Have self diagnostic failure detectors,
- Need minimum maintenance,
- Be simple to install, maintain and use
- Be sturdy and withstand extreme weather conditions obtainable in Mumbai

The signaling system shall be compatible with the traction system and the type of rolling stock proposed to be used, usable on continuous welded track from station to station.

The presence of a train on a line will be detected by track circuits provided all along the two lines for the entire route. The operation of the track circuit, when occupied by a train will control the aspect of the signals in rear.

As the traction proposed for the system is (25 KV AC) through overhead catenary, the track circuits must be direct current type. The track circuits shall work reliably within a range of 150 m to 1000 m. As for passenger comfort, continuous welded rails will be used for the track, joint-less track circuits will be used. Track circuit with glued joints can also be used.

Three aspect signals will be used as automatic signals with the following aspects

- | | |
|-----------|---|
| a) Red | for stop |
| b) Yellow | for approaching the next signal cautiously so that if necessary it may stop at the next signal. |
| c) Green | to proceed with maximum sectional speed |

The specifications for the system design and materials for all the system elements shall be similar to Indian Railways' specifications for ACLS.



CATP has not been proposed at the initial stages. It should, however, be possible to upgrade the system as and when required.

Driverless trains operation is not envisaged. If a bidder desires to do so to optimize O&M cost, complete details should be submitted covering technical, financial, operational & safety aspects.

10.0 PASSENGER INFORMATION SYSTEM:

The centralized clock system and passenger display system.

The clock system will comprise of the following components:

- Master clock (located in Central Control Building)
- Sub-master clock (located one in each operation area)
- Display units indicating hours and minutes only at different locations of stations and work centre.

Two master clocks shall be used in parallel in such a way that only one shall work and the other shall work in hot standby mode. The standby master clock shall take over the function as soon as the main one fails.

The master clock shall be crystal controlled high accuracy clock that sends a pulse train at regular interval of 1 sec to sub-master clocks or directly to slave clocks up to a distance of 2 km with suitable screened cable to drive up to 50 slave clocks.

The locations of slave clock will be decided by the Designated Engineer.

10.1 Indication Boards:

In all the stations, a number of passenger indicating Boards showing the next two train departure time in each direction will be provided. They will show the destination name in two languages viz: Marathi and English.

The indication Boards will be centrally controlled from OCC. Local intervention by Station Manager should be possible.

The indication on the board will be given by super high glow light emitting diodes. The LED indication shall be visible from 20 m with an ambient light of a bright sunny day in shade. Name of destination stations will be continuously lit without any change. Only the time of train for each direction will change.

Public address system covering concourse and platform areas adequately should be provided. It should be possible to make announcements either from station or OCC. The audio quality of the equipment should be suitable for crowded public areas.

11.0 INTERLOCKING SYSTEM:

- i) The points and crossings provided at stations for train reversals, diversions and emergency purposes should be operated from OCC and adequately interlocked with control signals to ensure safety and mobility of operations.
- ii) All points will be machine operated.



- iii) The system design, all equipments and material proposed to be used should generally be in accordance with the Indian Railways specifications, to the extent applicable or International practices adopted for similar systems. The detailed specifications will be drawn at the detailed engineering stage.
- iv) For control of train movements in the car-shed area, suitably designed panel-interlocking or Route Relay Interlocking as considered economical and operationally suitable, can be provided for, following Indian Railways specifications generally.
- The safety and operational efficiency will be the guiding principles for system design.

12.0 COMMUNICATION:

An appropriate reliable communication system shall be provided to satisfy the requirements of the applicable codes and standards. It shall be user- friendly and capable to provide passengers and MRTS staff with the relevant information, particularly under abnormal operating conditions. The availability of the system shall be close to 100%. The following shall constitute the minimum requirements:

- A two-way communication system between the drivers and the Operation Control Centre.
- A two-way communication system between passenger information points provided at each station platform and the Operation Control Centre.
- A two-way communication system between mobile supervisors, station masters, maintenance staff and the Operation Control Centre.
- A method of sending special messages to the passenger information display at each station platform.
- Capable of satisfactory operation in the field of electrical and electrostatic interference.
- The equipment shall be capable of withstanding adverse tropical weather conditions and power fluctuations.
- Emergency communication system usable by passengers at platforms and in trains. It shall be usable by disabled persons.
- Telecommunication system for use by management personnel. Appropriate mobile communication system for use by the drivers, operating and maintenance staff.
- Closed circuit TV system for passenger information normal and during emergency.
- CC TV system for security surveillance for all the stations.
- Public address system at station platforms that can be operated locally and from OCC.
- Public address system in train coaches for transmission of emergency information to passengers.

Fiber Optic Cables network to act as the carrier of all communication system.

13.0 DIGITAL ELECTRONIC EXCHANGE NETWORK:

- For proper communication, a digital electronic Telephone Exchange with approx. 500 lines capacity should be provided in the car shed area.
- All stations, supervisors, operators and maintenance points / locations should be suitably connected.
- Interface requirements of the network should be ascertained and provided for
- The equipment should be of proven-design suitable for railway environment.

14.0 TICKETING/FARE COLLECTION:



The fare collection system shall be designed to maximize revenue, minimize losses and the cost of issuing ticket by:

- User friendly, economical, reliable and vandal resistant ticketing equipment system,
- Easily understood by first-time travelers.
- Effective ticket checking to limit evasion.
- Closed system with paid and unpaid area in each station.
- Fare collection and passenger control will be completely through Automatic Fare Collection System
- Smart-card contact- less stored value tickets of various denominations for multiple journeys.
- For single /return journey, multiple commuter tickets, any other form of promotional/ concession tickets e.g. day ticket, suitably designed tokens will be issued. Smart Cards can also be used, if economical.
- The system will mainly consist of vending machines; add -value machines, entry and exit gates, computerized monitoring system, portable decoders with complete software and hardware etc. Some gates can be of reversible type to handle peak traffic.
- The equipment provided at every station should be adequate to handle projected commuter traffic and be capable of augmentation, if so needed. Spare equipment for every category should be provided for.
- In the event of malfunctioning of any equipment or non-acceptance of card / token by the machine, audio / visual warning should be provided for the user.
- It should be possible for most of the physically challenged persons to work through the system. At least one gate at every station should be designed for passengers on wheel chair.
- The bidder shall furnish complete details of the system proposed. Systems with proven technology only will be acceptable.

15.0 COMMISSIONING OF SYSTEM:

- Extensive trials will have to be conducted before Safety Commissioner is approached to inspect the system for declaring it fit for the public carriage of passengers.
- The main objective of such trials is to ascertain that the system as a whole functions as per design parameters and is safe for introduction of commercial services.
- The detailed format for the test/trials will be approved by the MMRDA Consultant. Safety Commissioner may also have to be consulted.
- Tests as prescribed by the suppliers of various sub-systems for the MRTS should also be conducted to check their performance and efficiency.
- Any additional Tests/Trials specifically ordered by Safety Commissioner should also be carried out.



- The concessionaire shall prepare Comprehensive Maintenance Manuals for all the assets of the MRTS including rolling stock and carry out maintenance operations as detailed out therein.
- Most of the equipment suppliers provide their own maintenance manuals system. The same should be fully considered while preparing Maintenance Manuals for MRT System modifying them to suit local conditions, if needed. The Manuals will provide detailed guidelines and maintenance/safety tolerances as approved by the Consultant / Designated Engineer. The checklists, formats for maintenance records and reporting etc. should also be included. The best international and local practices shall form the backbone of all maintenance operations/practices.
- The Maintenance Manuals should be finalized not less than 3 months in advance of scheduled date for commercial operations.
- The concessionaire will arrange to recruit and train adequate maintenance and supervisory staff well in time, so that they are available to ensure asset maintenance once the system becomes operational. This is a necessary pre-conditions for operations to commence.
- The recruitment standards for all operational, maintenance and managerial staff and their training needs must be finalized with the approval of Designated Engineer.
- All maintenance facilities must be planned not only to cater to immediate needs but also for future projected traffic.
- All normal maintenance operations shall have to be carried out during non-traffic hours and facilities should be provided accordingly.
- The frequency of inspections, items to be checked, maintenance tolerances etc. will be at detailed out in the Maintenance Manuals.
- Planned Renewals / Replacements and any other major maintenance works shall be carried out as per annual programme duly approved by the Designated Engineer.
- The maintenance works will be carried out either by in-house staff deployed by the concessionaire or through an experienced contracting agency employed for the purpose with the prior approval of the Designated Engineer. The maintenance strategy shall be finalized at least 3 months in advance of scheduled date of commercial operation.
- The supervisory staff for maintenance operations should be employed preferably on regular basis.
- Concessionaire must ensure availability of adequate spares and consumables at all times for various planned / emergent maintenances activities.
- Maintenance works to handle emergency situations can be carried out as the situation demands with a view to minimizing disruption to traffic, following detailed guidelines/procedures as given in the Disaster Management Manual and/or Maintenance Manual.



- For specialized equipment e.g. Automatic Fare Collection System, escalators, lifts/elevators, Fire Alarm/Protection System, Security surveillance system and any other similar system installed for safety, security and comfort of commuters, it may be necessary to enter into Annual Maintenance Contracts.
- For transport of men and material from maintenance depot to the work site during non-traffic hours, it would be desirable to deploy a self-propelled vehicle adequately equipped for various jobs including OHE – maintenance
- The cleanliness of station premises including all entry/exit passages, staircases, platforms etc. will have to be ensured to the highest standards at all times. During non-traffic maintenance hours thorough clearing operations should be planned for the entire area.
- The cleanliness of the way structure all along the corridor is of paramount importance from proper drainage, ease of maintenance and environmental considerations. This must be a planned activity as a daily routine.

18.0 Miscellaneous :

- Any operation and maintenance facility not listed above but considered essential for safe and efficient management of the MRTS shall be provided.
- The Technical and Performance specifications given in the volume are generally indicative and are not exhaustive. The detailed specifications will have to be finalised prior to the Project implementation.



- Appropriate test equipment/sensors etc. should be used to measure various parameters and record maintained thereof.
- All the requisite maintenance facilities should be commissioned before inspection of the system by Safety Commissioner.
- The operation and maintenance staff should be in place before the trials are conducted. Their knowledge of rules and procedures should be assessed along with MMRDA Consultant and Competency Certificate issued.
- Manuals for O & M of the MRTS covering all the disciplines should be finalized at least 3 months in advance of the commencement of Trial/Test runs.
- On successful completion of the pre-commissioning Tests/Trials, a formal application will be submitted to Safety Commissioner with a request to inspect the system and certify it fit for public carriage of passengers.
- Application to the Safety Commissioner shall furnish full technical information of the system. Results of tests/trials amenities for passengers maintenance facilities, staff training and certificates about safety and design adequacy of the system.
- The arrangement for handling emergencies on the system will have to be highlighted. The Disaster Management Manual should be prepared in advance, with the approval of MMRDA Consultants clearly indicating the systems – response to various eventualities.
- Inspection of lifts and escalators by the concerned Inspector, Fire Safety Certification of the project premises, NOC for opening of station buildings for public use by the Corporation will have to be ensured by the concessionaire before submission of application to the Safety Commissioner.
- The format for the application to Safety Commissioner will be finalized with approval of MMRDA Consultants. The Indian Railway's Rules for opening of a Railway can be referred to the extent applicable.
- The commercial services can be commenced only after necessary certification of the system by the Safety Commissioner.
- To ensure smooth operations, concessionaire may have to deploy adequate staff at stations temporarily to familiarize the commuters about certain new features of MRTS System e.g. Automatic Fare Collection, automatic closing of coach doors etc.

15.1 Test Runs:

1. Prototype vehicle will be used in empty as well as loaded condition during test runs. Load of passengers will be simulated by keeping concrete blocks on the floor of train.
2. Test runs would be done with all electrical equipment functioning normally as well as by cutting out one and two traction motor.
3. Test runs would be done by coupling another dead coach with prototype vehicle to assess capacity for towing.
4. Test runs would be done up to 100 kmph (20% more than maximum speed) in steps of 10 kmph from 40 kmph.
5. Starting and running adhesion test would be done on the prototype vehicle.



6. Ability to start on steepest gradient of 4% at minimum voltage with adequate acceleration reserve would be tested.
7. Ambient noise measurement – Measurement of harmonics and sophomoric currents in traction return circuits.

A well planned instrumentation scheme shall be chalked out to observe deflection. Stresses and settlements during the test run on the structures. Meticulous records of the same shall be maintained.

15.2 Extended Trial Runs:

Prototype vehicle after completion of test run would run in loaded (simulated) condition for 20 hours per day for a period of 3 months to determine reliability of system / equipment and maintainability.

16.0 OPERATION & MAINTENANCE:

16.1 Frequency of Train:

- Train consists and frequency of service shall be planned as per projected traffic. The average waiting time however, should be not more than 3 minutes (during peak hours) and 6 minutes during non-peak hours. The expected peak hours are from 08 to 1300 and 1700 to 2200 Hrs.
- The overall availability of services should be not less than 97% during 1st year of operation. During 2nd and subsequent years service availability should be atleast 99%.
- The service reliability should be very high. The MKBF should not be less than 100,000 kms.
- The general quality of service with regard to punctuality, coach cleanliness, lighting, public announcement etc. should be of highest as international standards as obtained on similar Transit System.
- The air-conditioning of coaches should be functional throughout the hours of operation. The temperature at grill level should be not higher than 22 degree centigrade.
- The safety and comfort of commuters is of the highest priority. This must be ensured at all times.
- The highest achievable quality of service is the only way to ensure full capacity utilization of MRTS and optimize fare box revenue. This must guide the total operational plan.
- Adequate operational, commercial and managerial staff must be recruited and trained well in time to manage operations efficiently. Hand - on experience on similar system must also be ensured at least for staff directly responsible for train operations.

17.0 MAINTENANCE MANUALS AND OTHER MAJOR REQUIREMENTS:

